

User Manual

Tektronix

**TPS2000 Series
Digital Storage Oscilloscope
071-1441-02**

Copyright © Tektronix, Inc. All rights reserved.

Tektronix products are covered by U.S. and foreign patents, issued and pending. Information in this publication supercedes that in all previously published material. Specifications and price change privileges reserved.

Tektronix, Inc., P.O. Box 500, Beaverton, OR 97077

TEKTRONIX, TEK, OpenChoice, and WaveStar are registered trademarks of Tektronix, Inc.

WARRANTY

TPS2000 Series Oscilloscopes

Tektronix warrants that the product listed above will be free from defects in materials and workmanship for a period of three (3) years from the date of original purchase from an authorized Tektronix distributor. If any such product proves defective during this warranty period, Tektronix, at its option, either will repair the defective product without charge for parts and labor, or will provide a replacement in exchange for the defective product. Batteries are excluded from this warranty. Parts, modules and replacement products used by Tektronix for warranty work may be new or reconditioned to like new performance. All replaced parts, modules and products become the property of Tektronix.

In order to obtain service under this warranty, Customer must notify Tektronix of the defect before the expiration of the warranty period and make suitable arrangements for the performance of service. Customer shall be responsible for packaging and shipping the defective product to the service center designated by Tektronix, shipping charges prepaid and with a copy of Customer proof of purchase. Tektronix shall pay for the return of the product to Customer if the shipment is to a location within the country in which the Tektronix service center is located. Customer shall be responsible for paying all shipping charges, duties, taxes, and any other charges for products returned to any other locations.

This warranty shall not apply to any defect, failure or damage caused by improper use or improper or inadequate maintenance and care. Tektronix shall not be obligated to furnish service under this warranty a) to repair damage resulting from attempts by personnel other than Tektronix representatives to install, repair or service the product; b) to repair damage resulting from improper use or connection to incompatible equipment; c) to repair any damage or malfunction caused by the use of non-Tektronix supplies; or d) to service a product that has been modified or integrated with other products when the effect of such modification or integration increases the time or difficulty of servicing the product.

WARRANTY (Continued)
TPS2000 Series Oscilloscopes

THIS WARRANTY IS GIVEN BY TEKTRONIX WITH RESPECT TO THE PRODUCT IN LIEU OF ANY OTHER WARRANTIES, EXPRESS OR IMPLIED. TEKTRONIX AND ITS VENDORS DISCLAIM ANY IMPLIED WARRANTIES OF MERCHANTABILITY OR FITNESS FOR A PARTICULAR PURPOSE. TEKTRONIX' RESPONSIBILITY TO REPAIR OR REPLACE DEFECTIVE PRODUCTS IS THE SOLE AND EXCLUSIVE REMEDY PROVIDED TO THE CUSTOMER FOR BREACH OF THIS WARRANTY. TEKTRONIX AND ITS VENDORS WILL NOT BE LIABLE FOR ANY INDIRECT, SPECIAL, INCIDENTAL, OR CONSEQUENTIAL DAMAGES IRRESPECTIVE OF WHETHER TEKTRONIX OR THE VENDOR HAS ADVANCE NOTICE OF THE POSSIBILITY OF SUCH DAMAGES.

WARRANTY

P2220 Probe

Tektronix warrants that the product listed above will be free from defects in materials and workmanship for a period of one (1) year from the date of original purchase from an authorized Tektronix distributor. If any such product proves defective during this warranty period, Tektronix, at its option, either will repair the defective product without charge for parts and labor, or will provide a replacement in exchange for the defective product. Batteries are excluded from this warranty. Parts, modules and replacement products used by Tektronix for warranty work may be new or reconditioned to like new performance. All replaced parts, modules and products become the property of Tektronix.

In order to obtain service under this warranty, Customer must notify Tektronix of the defect before the expiration of the warranty period and make suitable arrangements for the performance of service. Customer shall be responsible for packaging and shipping the defective product to the service center designated by Tektronix, shipping charges prepaid and with a copy of Customer proof of purchase. Tektronix shall pay for the return of the product to Customer if the shipment is to a location within the country in which the Tektronix service center is located. Customer shall be responsible for paying all shipping charges, duties, taxes, and any other charges for products returned to any other locations.

This warranty shall not apply to any defect, failure or damage caused by improper use or improper or inadequate maintenance and care. Tektronix shall not be obligated to furnish service under this warranty a) to repair damage resulting from attempts by personnel other than Tektronix representatives to install, repair or service the product; b) to repair damage resulting from improper use or connection to incompatible equipment; c) to repair any damage or malfunction caused by the use of non-Tektronix supplies; or d) to service a product that has been modified or integrated with other products when the effect of such modification or integration increases the time or difficulty of servicing the product.

WARRANTY (Continued)
P2220 Probe

THIS WARRANTY IS GIVEN BY TEKTRONIX WITH RESPECT TO THE PRODUCT IN LIEU OF ANY OTHER WARRANTIES, EXPRESS OR IMPLIED. TEKTRONIX AND ITS VENDORS DISCLAIM ANY IMPLIED WARRANTIES OF MERCHANTABILITY OR FITNESS FOR A PARTICULAR PURPOSE. TEKTRONIX' RESPONSIBILITY TO REPAIR OR REPLACE DEFECTIVE PRODUCTS IS THE SOLE AND EXCLUSIVE REMEDY PROVIDED TO THE CUSTOMER FOR BREACH OF THIS WARRANTY. TEKTRONIX AND ITS VENDORS WILL NOT BE LIABLE FOR ANY INDIRECT, SPECIAL, INCIDENTAL, OR CONSEQUENTIAL DAMAGES IRRESPECTIVE OF WHETHER TEKTRONIX OR THE VENDOR HAS ADVANCE NOTICE OF THE POSSIBILITY OF SUCH DAMAGES.

WARRANTY

TPSBAT Battery Pack

Tektronix warrants that the product listed above will be free from defects in materials and workmanship for a period of three (3) months from the date of original purchase from an authorized Tektronix distributor. If any such product proves defective during this warranty period, Tektronix, at its option, either will repair the defective product without charge for parts and labor, or will provide a replacement in exchange for the defective product. Parts, modules and replacement products used by Tektronix for warranty work may be new or reconditioned to like new performance. All replaced parts, modules and products become the property of Tektronix.

In order to obtain service under this warranty, Customer must notify Tektronix of the defect before the expiration of the warranty period and make suitable arrangements for the performance of service. Customer shall be responsible for packaging and shipping the defective product to the service center designated by Tektronix, shipping charges prepaid, and with a copy of customer proof of purchase. Tektronix shall pay for the return of the product to Customer if the shipment is to a location within the country in which the Tektronix service center is located. Customer shall be responsible for paying all shipping charges, duties, taxes, and any other charges for products returned to any other locations.

This warranty shall not apply to any defect, failure or damage caused by improper use or improper or inadequate maintenance and care. Tektronix shall not be obligated to furnish service under this warranty a) to repair damage resulting from attempts by personnel other than Tektronix representatives to install, repair or service the product; b) to repair damage resulting from improper use or connection to incompatible equipment; c) to repair any damage or malfunction caused by the use of non-Tektronix supplies; or d) to service a product that has been modified or integrated with other products when the effect of such modification or integration increases the time or difficulty of servicing the product.

WARRANTY (Continued)
TPSBAT Battery Pack

THIS WARRANTY IS GIVEN BY TEKTRONIX WITH RESPECT TO THE PRODUCT IN LIEU OF ANY OTHER WARRANTIES, EXPRESS OR IMPLIED. TEKTRONIX AND ITS VENDORS DISCLAIM ANY IMPLIED WARRANTIES OF MERCHANTABILITY OR FITNESS FOR A PARTICULAR PURPOSE. TEKTRONIX' RESPONSIBILITY TO REPAIR OR REPLACE DEFECTIVE PRODUCTS IS THE SOLE AND EXCLUSIVE REMEDY PROVIDED TO THE CUSTOMER FOR BREACH OF THIS WARRANTY. TEKTRONIX AND ITS VENDORS WILL NOT BE LIABLE FOR ANY INDIRECT, SPECIAL, INCIDENTAL, OR CONSEQUENTIAL DAMAGES IRRESPECTIVE OF WHETHER TEKTRONIX OR THE VENDOR HAS ADVANCE NOTICE OF THE POSSIBILITY OF SUCH DAMAGES.

Table of Contents

General Safety Summary	vii
Preface	xi
Help System	xiii
Conventions	xv
Product Stewardship	xvi
Battery Packs	xvi
End-of-Life Handling	xvi
Contacting Tektronix	xvii

Getting Started

General Features	1-2
Taking Floating Measurements	1-4
Probe Connection	1-5
Attach the Reference Leads Correctly	1-6
BNC Connectors	1-6
Unterminated BNC Inputs	1-6
Installation	1-7
Battery Packs	1-8
Charging Battery Packs	1-10
Power Cord	1-10
Versatile Hanger	1-10
Security Lock	1-12
Probes	1-13
Functional Check	1-13
Probe Safety	1-15
Voltage Probe Check Wizard	1-16
Manual Voltage Probe Compensation	1-17
Voltage Probe Attenuation Setting	1-19
Current Probe Scaling	1-20
Self Calibration	1-20

Operating Basics

Display Area	2-2
Message Area	2-5
Using the Menu System	2-6
Vertical Controls	2-8
Horizontal Controls	2-9
Trigger Controls	2-10
Menu and Control Buttons	2-11
Input Connectors	2-15
Other Front-Panel Items	2-16

Understanding Oscilloscope Functions

Setting Up the Oscilloscope	3-2
Using Autoset	3-2
Using Autorange	3-2
Saving a Setup	3-2
Recalling a Setup	3-3
Default Setup	3-3
Triggering	3-3
Source	3-4
Types	3-4
Modes	3-5
Coupling	3-5
Position	3-5
Slope and Level	3-6
Acquiring Signals	3-6
Acquisition Modes	3-6
Time Base	3-7
Scaling and Positioning Waveforms	3-8
Vertical Scale and Position	3-8
Horizontal Scale and Position; Pretrigger Information	3-8
Taking Measurements	3-14
Graticule	3-14
Cursors	3-15
Automatic	3-15

Application Examples

Taking Simple Measurements	4-2
Using Autoset	4-3
Taking Automatic Measurements	4-3
Measuring Two Signals	4-5
Using Autorange to Examine a Series of Test Points	4-8
Using an Isolated Channel to Analyze a Differential Communication Signal	4-9
Viewing a Math Instantaneous Power Waveform	4-11
Taking Cursor Measurements	4-13
Measuring Ring Frequency and Amplitude	4-13
Measuring Pulse Width	4-15
Measuring Rise Time	4-17
Analyzing Signal Detail	4-19
Looking at a Noisy Signal	4-19
Separating the Signal from Noise	4-20
Capturing a Single-Shot Signal	4-21
Optimizing the Acquisition	4-22
Measuring Propagation Delay	4-23
Triggering on a Specific Pulse Width	4-25
Triggering on a Video Signal	4-27
Triggering on Video Fields	4-28
Triggering on Video Lines	4-29
Using the Window Function to See Waveform Details ...	4-31
Viewing Impedance Changes in a Network	4-32

Math FFT

Setting Up the Time-Domain Waveform	5-2
Displaying the FFT Spectrum	5-4
Selecting an FFT Window	5-6
Magnifying and Positioning an FFT Spectrum	5-10
Measuring an FFT Spectrum Using Cursors	5-11

Communications (RS-232 and Centronics)

Sending a Screen Image to an External Device	6-1
Setting Up and Testing the RS-232 Interface	6-5
Command Entry	6-13

Removable Mass Storage

Installing and Removing a CompactFlash (CF) Card	7-1
CF Card Initial Read Time	7-2
Formatting a CF Card	7-2
CF Card Capacities	7-3
File Management Conventions	7-3
Using the Save function of the PRINT Button	7-4
Saves All to Files	7-5
Saves Image to File	7-7

Managing TPSBAT Battery Packs

Caring for Battery Packs	8-1
Continuous Charging	8-2
Charging Temperature	8-2
Discharging Temperature	8-2
Short Term Storage	8-3
Long Term Storage	8-3
Service Life	8-3
Transportation Information	8-4
Checking the Charge and Calibration Status	8-5
Charging Battery Packs	8-6
Internal Charge	8-6
External Charge	8-7
Partial Charge	8-8
Calibrating Battery Packs	8-8
External Calibration	8-9
Internal Calibration	8-10
Replacing Battery Packs	8-11

Reference

Acquire	9-2
Application	9-6
Autorange	9-7
Autoset	9-10
Sine Wave	9-12
Square Wave or Pulse	9-13
Video Signal	9-14
Cursor	9-15
Default Setup	9-16
Display	9-17
Help	9-21
Horizontal	9-21
Math	9-24
Measure	9-25
Print	9-27
Probe Check	9-28
Save/Recall	9-28
Trigger Controls	9-36
Utility	9-47
Vertical	9-52

Appendices

Appendix A: Specifications	A-1
Appendix B: Accessories	B-1
Appendix C: Cleaning	C-1
Appendix D: Default Setup	D-1
Appendix E: Font Licenses	E-1
Appendix F: TPS2000 Compatible Probe Maximum Voltages	F-1

Index

General Safety Summary

Review the following safety precautions to avoid injury and prevent damage to this product or any products connected to it.

To avoid potential hazards, use this product only as specified.

Only qualified personnel should perform service procedures.

To Avoid Fire or Personal Injury

Use Proper Power Cord. Use only the power cord specified for this product and certified for the country of use.

Connect and Disconnect Properly. Do not connect or disconnect probes or test leads while they are connected to a voltage source.

Connect and Disconnect Properly. Connect the probe output to the measurement instrument before connecting the probe to the circuit under test. Disconnect the probe input and the probe reference lead from the circuit under test before disconnecting the probe from the measurement instrument.

Observe All Terminal Ratings. To avoid fire or shock hazard, observe all ratings and markings on the product. Consult the product manual for further ratings information before making connections to the product.

Use Proper Probe. To avoid shock hazard, use a properly rated probe for your measurement.

Floating. Do not float the P2220 probe reference lead to $> 30 \text{ V}_{\text{RMS}}$. Use the P5120 (floatable to $600 \text{ V}_{\text{RMS}}$ CAT II or $300 \text{ V}_{\text{RMS}}$ CAT III) or similarly rated, passive, high voltage probe or an appropriately rated, high voltage differential probe when floating the reference lead above $30 \text{ V}_{\text{RMS}}$, subject to the ratings of such high voltage probe.

Powering Off. The power cord provides Mains disconnect.

Replace Batteries Properly. Replace batteries only with the proper type and rating specified.

Recharge Batteries Properly. Recharge batteries for the recommended charge cycle only.

Use Proper AC Adapter. Use only the AC adapter specified for this product.

Do Not Operate Without Covers. Do not operate this product with covers or panels removed.

Avoid Exposed Circuitry. Do not touch exposed connections and components when power is present.

Do Not Operate With Suspected Failures. If you suspect there is damage to this product, have it inspected by qualified service personnel.

Environment. Pollution Degree 2¹. Do not operate in an environment where conductive pollutants may be present. See Appendix A for Environmental characteristics.

Do Not Operate in Wet/Damp Conditions.

Do Not Operate in an Explosive Atmosphere.

Keep Product Surfaces Clean and Dry.

Provide Proper Ventilation. Refer to the manual's installation instructions for details on installing the product so it has proper ventilation.

¹ As defined in IEC61010-1:2001.

Symbols and Terms

Terms in This Manual. These terms may appear in this manual:



WARNING. *Warning statements identify conditions or practices that could result in injury or loss of life.*



CAUTION. *Caution statements identify conditions or practices that could result in damage to this product or other property.*

Terms on the Product. These terms may appear on the product:

DANGER indicates an injury hazard immediately accessible as you read the marking.

WARNING indicates an injury hazard not immediately accessible as you read the marking.

CAUTION indicates a hazard to property including the product.

Symbols on the Product. These symbols may appear on the product:



CAUTION
Refer to Manual



Standby



Chassis Ground

Preface

This manual contains operating information for the TPS2000 Series Digital Storage Oscilloscopes. The manual consists of the following chapters:

- The *Getting Started* chapter briefly describes features of the oscilloscope and provides installation instructions.
- The *Operating Basics* chapter covers operating principles of the oscilloscopes.
- The *Understanding Oscilloscope Functions* chapter describes basic operations and functions of an oscilloscope: setting up the oscilloscope, triggering, acquiring data, scaling and positioning waveforms, and taking measurements.
- The *Application Examples* chapter includes examples of a wide variety of measurements to give you ideas on how to solve your own measurement problems.
- The *Math FFT* chapter describes how to use the Math Fast Fourier Transform function to convert a time-domain signal into its frequency components (spectrum).

- The *Communications* chapter describes how to set up the RS-232 and Centronics ports to use the oscilloscope with external devices, such as printers and computers.
- The *Removable Mass Storage* chapter describes how to use a CompactFlash card and oscilloscope functions available when a card is in use.
- The *Managing TPSBAT Battery Packs* chapter describes how to use, charge, calibrate, and replace battery packs.
- The *Reference* chapter describes the selections or available range of values for each option.
- The *Appendix A: Specifications* chapter includes electrical, environmental, and physical specifications for the oscilloscope and the P2220 probe, as well as certifications and compliances.
- The *Appendix B: Accessories* chapter briefly describes standard and optional accessories.
- The *Appendix C: General Care and Cleaning* chapter describes how to take care of the oscilloscope.
- The *Appendix D: Default Setup* chapter contains a list of the menus and controls with the default (factory) settings that are recalled when you push the DEFAULT SETUP front-panel button.

Help System

The oscilloscope has a Help system with topics that cover all the features of the oscilloscope. You can use the Help system to display several kinds of information:

- General information about understanding and using the oscilloscope, such as *Using the Menu System*.
- Information about specific menus and controls, such as the *Vertical Position Control*.
- Advice about problems you may face while using an oscilloscope, such as *Reducing Noise*.

The Help system provides several ways to find the information you need: context-sensitive, hyperlinks, and an index.

Context-Sensitive

The oscilloscope displays information about the last menu displayed on the screen when you push the **HELP** front-panel button. When viewing help topics, an **LED** lights next to the multipurpose knob to indicate that the knob is active. If the topic uses more than one page, turn the multipurpose knob to move from page to page within the topic.

Hyperlinks

Most of the help topics contain phrases marked with angle brackets, such as <Autoset>. These are links to other topics. Turn the multipurpose knob to move the highlight from one link to another. Push the Show Topic option button to display the topic corresponding to the highlighted link. Push the Back option button to return to the previous topic.

Index

Push the front-panel HELP button, then push the Index option button. Push the Page Up or Page Down option buttons until you find the index page that contains the topic you want to view. Turn the multipurpose knob to highlight a help topic. Push the Show Topic option button to display the topic.

NOTE. *Push the Exit option button or any menu button to remove the Help text from the screen and return to displaying waveforms.*

Conventions

This manual uses the following conventions:

- Front-panel buttons, knobs and connectors appear in all uppercase letters. For example: HELP, PRINT.
- Menu options appear with the first letter of each word in upper case. For example: Peak Detect, Window Zone.

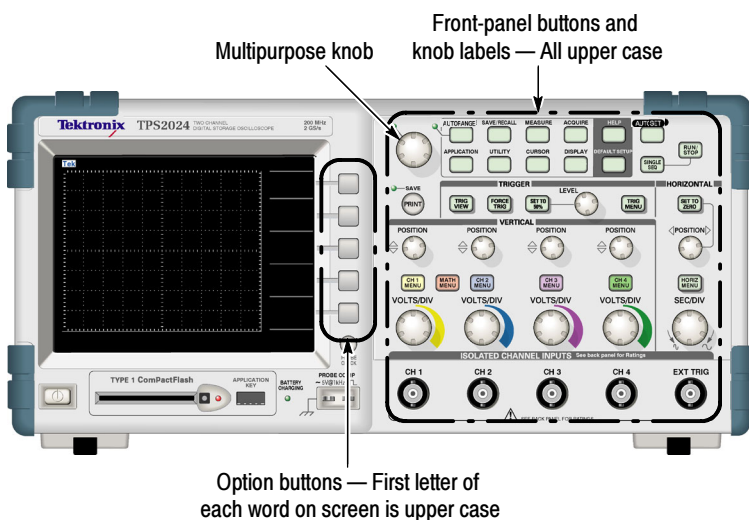

NOTE. Option buttons can also be called screen buttons, side-menu buttons, bezel buttons, or soft keys.

- The ▶ delimiter separates a series of button pushes. For example, **UTILITY ▶ Options ▶ RS-232 Setup** means that you push the UTILITY front-panel button, then push the Options option button, and then push the RS-232 Setup option button.

Product Stewardship

Battery Packs

This product contains lithium-ion (Li-Ion) battery packs that should be recycled or disposed of properly in accordance with local laws or regulations. For the location of a local battery recycler in the U.S. or Canada, please contact:

RBRC
Rechargeable Battery Recycling Corp.
P.O. Box 141870
Gainesville, Florida 32614

(800) BATTERY
(800) 227-7379
www.rbrc.com

End-of-Life Handling

Electronic products should be recycled or disposed of properly in accordance with local laws or regulations. Contact a local Tektronix representative if you require assistance in recycling your Tektronix product.

TPS2000 Series Digital Storage Oscilloscopes contain a cold cathode fluorescent lamp within the oscilloscope display that contains trace amounts of mercury. If required by local law or regulation, the display assembly or lamp must be placed into a recovery program designated for mercury-containing materials.

Contacting Tektronix

Phone	1-800-833-9200*
Address	Tektronix, Inc. Department or name (if known) 14200 SW Karl Braun Drive P.O. Box 500 Beaverton, OR 97077 USA
Web site	www.tektronix.com
Sales support	1-800-833-9200, select option 1*
Service support	1-800-833-9200, select option 2*
Technical support	Email: techsupport@tektronix.com 1-800-833-9200, select option 3* 6:00 a.m. - 5:00 p.m. Pacific time

- * **This phone number is toll free in North America. After office hours, please leave a voice mail message. Outside North America, contact a Tektronix sales office or distributor; see the Tektronix web site for a list of offices.**



Getting Started

Getting Started

TPS2000 Series Digital Storage Oscilloscopes are small, lightweight, battery-powered, portable oscilloscopes. In addition to the list of general features on the next page, this chapter describes how to do the following tasks:

- Take floating measurements
- Install your product
- Charge battery packs
- Perform a brief functional check
- Perform a probe check and compensate probes
- Match your probe attenuation factor
- Use the self calibration routine

NOTE. *You can select a language to display on the screen when you power on the oscilloscope. At any time, you can also access the **UTILITY** ► **Language** option to select a language.*

General Features

The next table and list describe the general features.

Model	Channels	Bandwidth	Sample rate
TPS2012	2	100 MHz	1.0 GS/s
TPS2014	4	100 MHz	1.0 GS/s
TPS2024	4	200 MHz	2.0 GS/s

- Battery powered or line powered
- Two rechargeable battery packs (second battery pack optional)
- Independently isolated channels with no shared common ground
- TPS2PWR1 Power Analysis application (optional)
- Support for compatible voltage probes and current probes
- Context-sensitive help system
- Color LCD display
- Selectable 20 MHz bandwidth limit
- 2500 point record length for each channel
- Autoset

- Autoranging for quick set up and hands-free operation
- Probe Check Wizard
- Cursors with readouts
- Trigger frequency readout
- Eleven automatic measurements
- Waveform averaging and peak detection
- Dual time base
- Math functions: +, -, and \times operations
- Math Fast Fourier Transform (FFT)
- Pulse Width trigger capability
- Video trigger capability with line-selectable triggering
- External trigger
- Setup and waveform storage
- Removable mass storage
- Variable persistence display
- RS-232 and Centronics ports
- OpenChoice PC Communications software
- User interface in ten user-selectable languages

Taking Floating Measurements

For taking floating measurements, the oscilloscope channel and Ext Trig inputs ($3\text{ M}\Omega$) are isolated from the oscilloscope chassis and from each other. This allows independent floating measurements with channel 1, channel 2, and Ext Trig (and with channel 3 and channel 4 on four channel models).

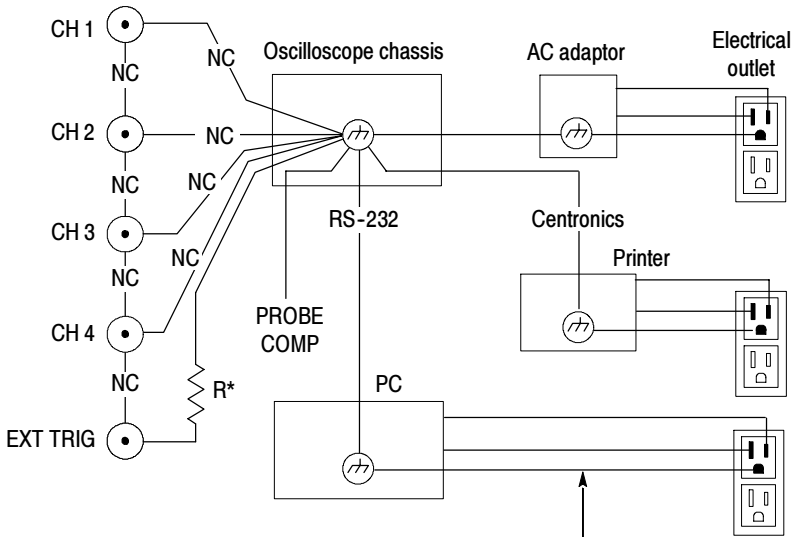

* $3\text{ M}\Omega$ impedance.
NC means not connected.

Connected to earth ground by building wiring,
typical of a North American building.

The oscilloscope inputs float even when the oscilloscope is connected to a grounded power supply, a grounded printer, or a grounded computer.

Most other oscilloscopes share a common reference for the oscilloscope channel and Ext Trig inputs. This reference is typically connected to earth ground through the power cord. With common-referenced oscilloscopes, all input signals must have the same common reference when you take any multi-channel measurements.

Without differential preamplifiers or external signal isolators, common-referenced oscilloscopes are not suitable for taking floating measurements.

Probe Connection



WARNING. *To prevent electrical shock, do not exceed the measurement or floating voltage ratings for the oscilloscope input BNC connector, probe tip, or probe reference lead.*

Understand the voltage ratings for the probes you are using and do not exceed those ratings. The following voltage ratings are important to know and understand:

- The maximum measurement voltage from the probe tip and BNC signal to the probe reference lead
- The maximum measurement voltage from the probe tip and BNC shell to earth ground
- The maximum floating voltage from the probe reference lead to earth ground



WARNING. *To avoid an electric shock, do not use probes that require a ground connection, such as the Tektronix P5200 High Voltage Differential Probe, with the TPS2000 series oscilloscopes. The P5200 High Voltage Differential Probe requires an oscilloscope with grounded inputs and the TPS2000 series oscilloscopes have floating inputs (isolated inputs).*



WARNING. Do not float the P2220 probes reference lead to > 30 V_{RMS}. Use the P5120 (floatable to 600 V_{RMS} CAT II or 300 V_{RMS} CAT III) or similarly rated, passive, high voltage probe or an appropriately rated, high voltage, differential probe when floating the reference lead above 30 V_{RMS}, subject to the ratings of such high voltage probe.

These voltage ratings depend on the probe and your application. Refer to *Specifications* on page A-1 for more information.

For more information on probe safety, see page 1-15.

Attach the Reference Leads Correctly

You must attach the probe reference lead for each channel directly to your circuit. These attachments are required because the oscilloscope channels are electrically isolated; they do not share a common connection. Use the shortest possible reference lead with each probe to maintain good signal fidelity.

The probe reference lead presents a higher capacitive load to the circuit under test than the probe tip. When taking a floating measurement between two nodes of a circuit, attach the probe reference lead to the lowest impedance or least dynamic of the two nodes.

BNC Connectors

The oscilloscope BNC reference connection is made on the inside of the BNC connector. The black bayonet on the outside of the BNC connectors does not provide electrical contact. For a good connection, make sure your probe or cable connector is pushed on and twist locked. Replace cables or probes that have worn connectors.

Unterminated BNC Inputs

The black bayonet on the outside of the BNC input connectors does not shield the connector input from unwanted electrical noise from nearby circuits. Connect a 50 ohm terminator or a BNC shorting plug to the input BNC connector when establishing a “No Signal” baseline condition.

Installation

You can use the oscilloscope AC adaptor to power the oscilloscope or to charge battery packs when installed. To use the oscilloscope AC adaptor as the power source, follow these steps:

1. Insert the DC connector end of the adaptor into the DC INPUT connector on the back of the oscilloscope.
2. Connect the appropriate power cord between the oscilloscope AC adaptor and an electrical outlet.

If battery packs are installed, an LED lights on the front of the oscilloscope to indicate when the battery packs are charging.

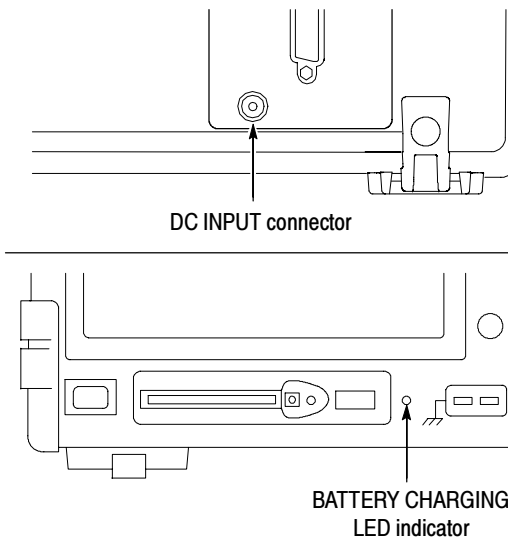

NOTE. The oscilloscope contains a temperature-sensing fan for cooling that forces air through vents on the bottom and on the side of the oscilloscope. To allow air to flow freely through the oscilloscope, do not block these vents.

Battery Packs

The oscilloscope can accommodate two TPSBAT battery packs. The product includes one battery pack that is not installed when shipped. The amount of time you can operate the oscilloscope with battery packs depends on the oscilloscope model.

Oscilloscope	Amount of time to operate
2 channel	5.5 hours on one battery pack, 11 hours on two
4 channel	4.5 hours on one battery pack, 9 hours on two

NOTE. A message displays when there are approximately 10 minutes of operating time left on the battery packs.

For details on how to use, charge, calibrate, and replace battery packs, refer to Managing TPSBAT Battery Packs on page 8-1. For example, battery packs need to be calibrated to accurately report available operating time.

To install battery packs, follow these steps:

1. Press the battery compartment door latch on the the right side panel and open the battery compartment.

2. Orient the battery pack as shown on the oscilloscope, and install the pack. Battery packs are keyed, so you can insert them only one way.

For single battery pack use, install a pack in the lower receptacle. This lowers the center of gravity.

3. Close the battery compartment door.

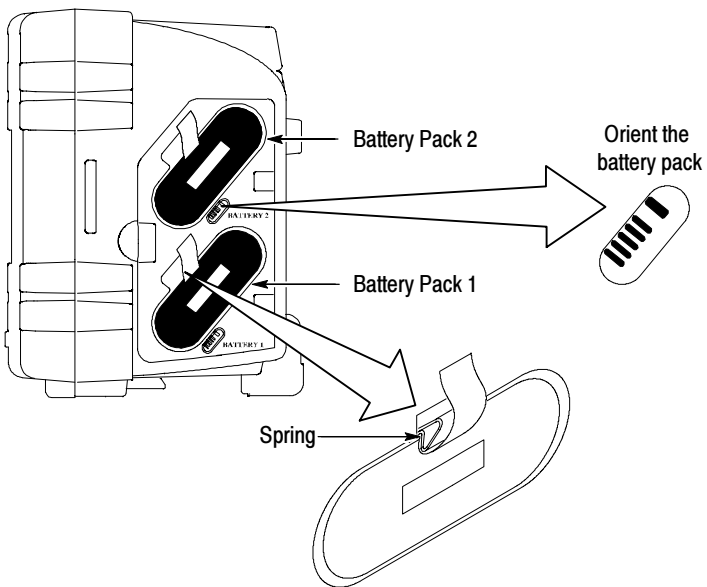

To remove the battery packs, follow these steps:

1. Press the battery compartment door latch on the the right side panel and open the battery compartment.
2. Grab the strap and lift up.
3. Push the spring clip towards the outside of the battery pack and pull the strap to remove the battery pack.
4. Close the battery compartment door.

Charging Battery Packs

You can charge the battery packs in an oscilloscope or with the TPSCHG external battery charger. See page 8-6.

Power Cord

Use only power cords designed for the AC adaptor for the oscilloscope or external charger. The AC adaptor for the oscilloscope and external charger requires 90 to 264 VAC_{RMS}, 45 to 66 Hz. Refer to page B-2 for a list of available power cords.

Versatile Hanger

Use the versatile hanger to securely suspend the oscilloscope when you cannot place it on a stable surface, such as on a bench top.

To attach the hanger, follow these steps:

1. Position a hanger clip over one of the feet on the rear case so the clip is flat against the case. Orient the slot at the top of the clip.
2. Push the clip up towards the top of the case to snap it in place.

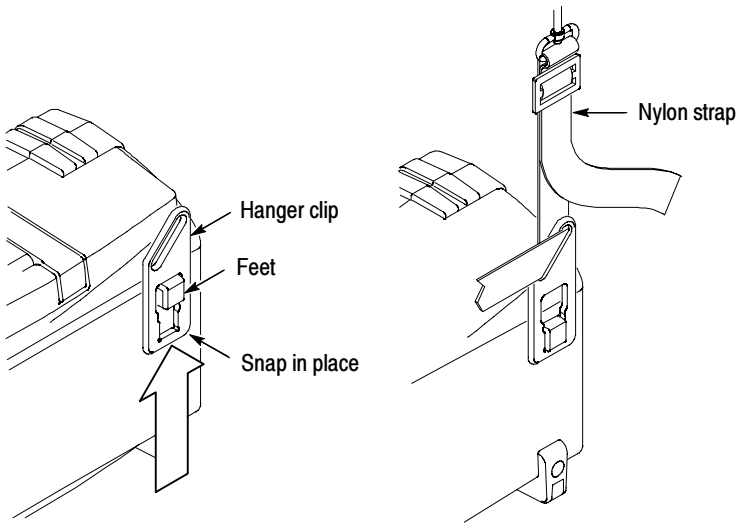

3. Repeat steps 1 and 2 for the other clip.
4. Adjust the length of the nylon strap. A short strap helps to keep the oscilloscope stationary while suspended.

NOTE. You can route the nylon strap through the handle on the oscilloscope to provide a more stable center of gravity.

5. Place the hooks over a vertical support, such as a wall partition or an instrument rack door.

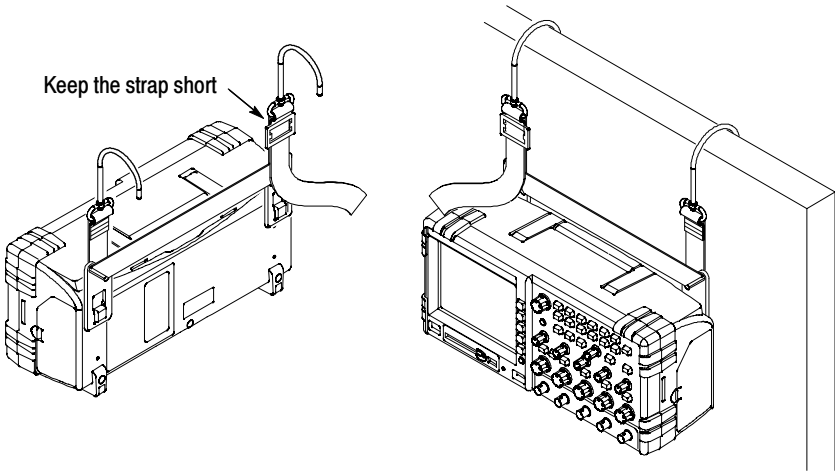

Security Lock

Use a standard laptop computer security cable to secure your oscilloscope to your location.

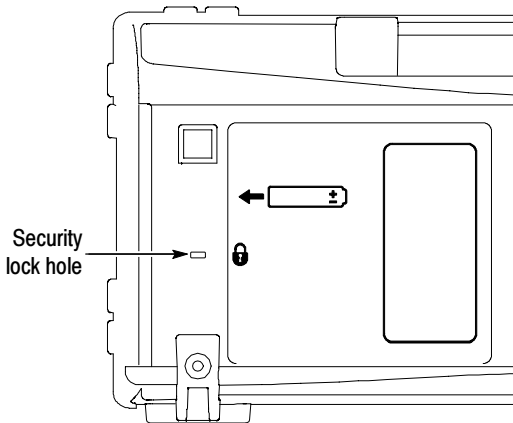

Probes

TPS2000 series oscilloscopes ship with P2220 passive voltage probes. See page 1-15 for probe safety. See Appendix A for specifications.

You can use many Tektronix voltage probes and current probes with these oscilloscopes. Refer to Appendix B or the www.Tektronix.com web site for a list of compatible probes.

Functional Check

Perform this functional check to verify that your oscilloscope is operating correctly.

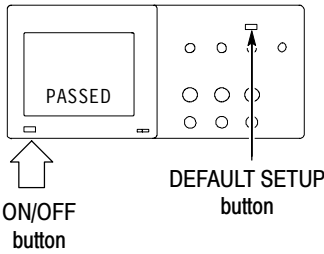

1. Power on the oscilloscope.

Read the probe warning. Then push OK. Push the DEFAULT SETUP button. The default Voltage Probe Attenuation option is 10X.

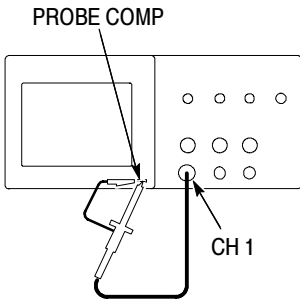

2. Set the switch to 10X on the P2220 probe and connect the probe to channel 1 on the oscilloscope. To do this, align the slot in the probe connector with the key on the CH 1 BNC, push to connect, and twist to the right to lock the probe in place.

Connect the probe tip and reference lead to the PROBE COMP terminals.

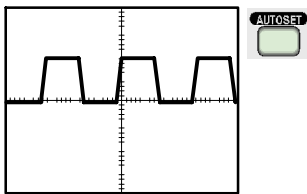

3. Push the AUTOSET button. Within a few seconds, you should see a square wave in the display of about 5 V peak-to-peak at 1 kHz.

Push the CH 1 MENU button twice to remove channel 1, push the CH 2 MENU button to display channel 2, repeat steps 2 and 3. For 4-channel models, repeat for CH 3 and CH 4.

Probe Safety

Check and observe probe ratings before using probes.

A guard around the P2220 voltage probe body provides a finger barrier for protection from electric shock.

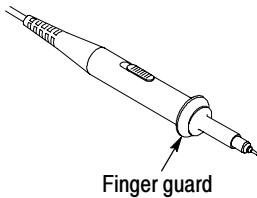

WARNING. To avoid electric shock when using the probe, keep fingers behind the guard on the probe body.

To avoid electric shock while using the probe, do not touch metallic portions of the probe head while it is connected to a voltage source.

Connect the probe to the oscilloscope before you connect the probe to your circuit to take any measurements.

Any non-attenuating probe that applies more than 150 VAC to the oscilloscope BNC input connector must be third party certified with the probe reference lead rated to float to 300 V CAT II.

For information on isolated channels and floating measurements, see page 1-4. For information on high voltages, see page 1-5.



WARNING. Do not float the P2220 probe reference lead to $> 30 V_{RMS}$. Use the P5120 (floatable to 600 V_{RMS} CAT II or 300 V_{RMS} CAT III) or similarly rated, passive, high voltage probe or an appropriately rated, high voltage, differential probe when floating the reference lead above 30 V_{RMS}, subject to the ratings of such high voltage probe.

Voltage Probe Check Wizard

You can use the Probe Check Wizard to verify that a voltage probe is operating properly. The wizard does not support current probes.

The wizard helps you adjust the compensation for voltage probes (usually with a screw on the probe body or probe connector) and set the factor for the Attenuation option for each channel, such as in the **CH 1 MENU ▶ Probe ▶ Voltage ▶ Attenuation** option.

You should use the Probe Check Wizard each time you connect a voltage probe to an input channel.

To use the Probe Check Wizard, push the PROBE CHECK button. If the voltage probe is connected properly, compensated properly, and the Attenuation option in the oscilloscope VERTICAL menu is set to match the probe, the oscilloscope displays a PASSED message at the bottom of the screen. Otherwise, the oscilloscope displays directions on the screen to guide you in correcting these problems.

NOTE. *The Probe Check Wizard is useful for 1X, 10X, 20X, 50X, and 100X voltage probes. It is not useful for 500X or 1000X probes, or for probes connected to the EXT TRIG BNC.*

NOTE. *When the process is complete, the Probe Check Wizard restores the oscilloscope settings (other than the Probe and the Attenuation options) to what they were before you pushed the **PROBE CHECK** button.*

To compensate a probe that you plan to use with the EXT TRIG input, follow these steps:

1. Connect the probe to any input channel BNC, such as to CH 1.
2. Push the **PROBE CHECK** button and follow the directions on the screen.
3. After you verify that the probe functions and is compensated properly, connect the probe to the EXT TRIG BNC.

Manual Voltage Probe Compensation

As an alternative method to the Probe Check Wizard, you can manually perform this adjustment to match your voltage probe to the input channel.

NOTE. *Be sure to properly connect the voltage probe reference lead to the **PROBE COMP** reference terminal because the oscilloscope channels are isolated from the **PROBE COMP** terminals.*

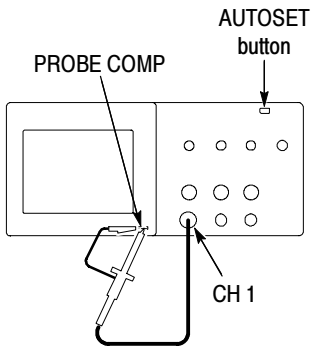

1. Push the CH 1 Menu button and set the Voltage Probe Attenuation option to 10X. Set the switch to 10X on the P2220 probe and connect the probe to channel 1 on the oscilloscope. If you use the probe hook-tip, ensure a proper connection by firmly inserting the tip onto the probe.
2. Attach the probe tip to the PROBE COMP ~5V@1kHz terminal and the reference lead to the PROBE COMP chassis terminal. Display the channel, and then push the AUTOSET button.



Overcompensated

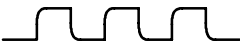

Undercompensated



Compensated correctly

3. Check the shape of the displayed waveform.

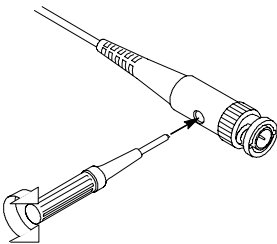

4. If necessary, adjust your probe. The P2220 voltage probe is shown.

Repeat as necessary.

Voltage Probe Attenuation Setting

Voltage probes have various attenuation factors which affect the vertical scale of the signal. The Probe Check Wizard verifies that the attenuation factor in the oscilloscope matches the probe.

As an alternative method to Probe Check, you can manually select the factor that matches the attenuation of your probe. For example to match a probe set to 10X connected to CH 1, you would access the **CH 1 MENU** ▶ **Probe** ▶ **Voltage** ▶ **Attenuation** option and select 10X.

NOTE. *The default setting for the Attenuation option is 10X.*

If you change the Attenuation switch on the P2220 probe, you also need to change the oscilloscope Attenuation option to match. Switch settings are 1X and 10X.

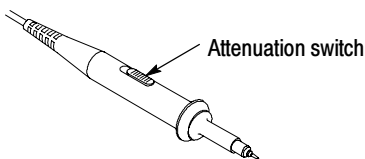

NOTE. *When the Attenuation switch is set to 1X, the P2220 probe limits the bandwidth of the oscilloscope to 6 MHz. To use the full bandwidth of the oscilloscope, be sure to set the switch to 10X.*

Current Probe Scaling

Current probes provide a voltage signal proportional to the current. You need to set the oscilloscope to match the scale of your current probe. The default scale is 10 A/V.

To set the scale, follow these steps:

1. Push a vertical channel button (such as the **CH 1 MENU** button).
2. Push the **Probe** option button.
3. Push the **Current** option button.
4. Push the **Scale** option button to select an appropriate value.

Self Calibration

The self calibration routine lets you optimize the oscilloscope signal path for maximum measurement accuracy. You can run the routine at any time but you should always run the routine if the ambient temperature changes by 5 °C (9 °F) or more. For accurate calibration, power on the oscilloscope and wait twenty minutes to ensure it is warmed up.

To compensate the signal path, disconnect any probes or cables from the input connectors. Then, access the **UTILITY ▶ Do Self Cal** option and follow the directions on the screen.

The self calibration routine takes about two minutes.



Operating Basics

Operating Basics

The front panel is divided into easy-to-use functional areas. This chapter provides you with a quick overview of the controls and the information displayed on the screen.

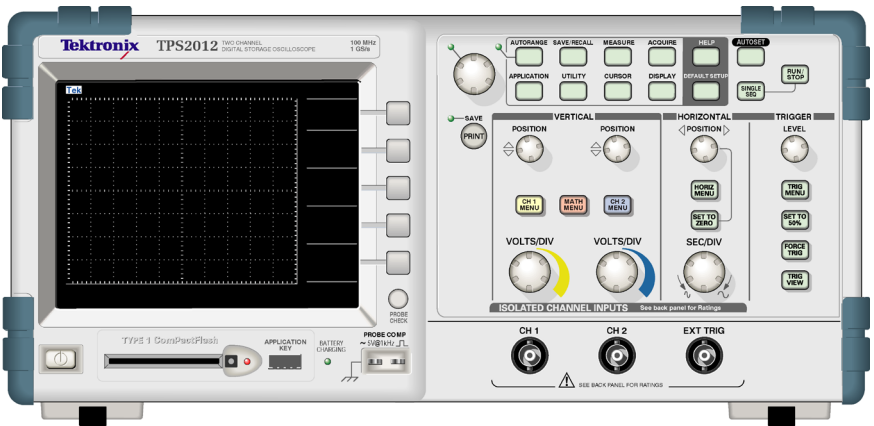

2-channel model

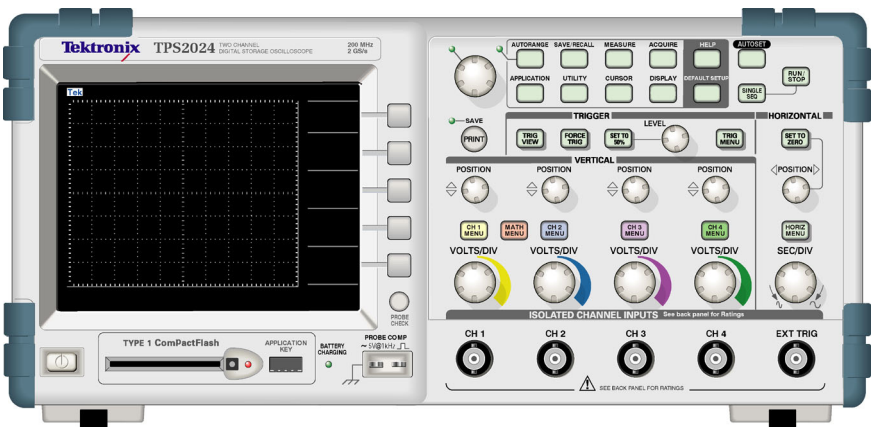

4-channel models

The front panel buttons can be illuminated (through the Utilities menu). This illumination does not significantly affect the duration of the charge on the battery packs when you operate the oscilloscope from battery packs only.

Display Area

In addition to displaying waveforms, the display is filled with many details about the waveform and the oscilloscope control settings.

NOTE. For details on displaying the FFT function, refer to page 5-5.

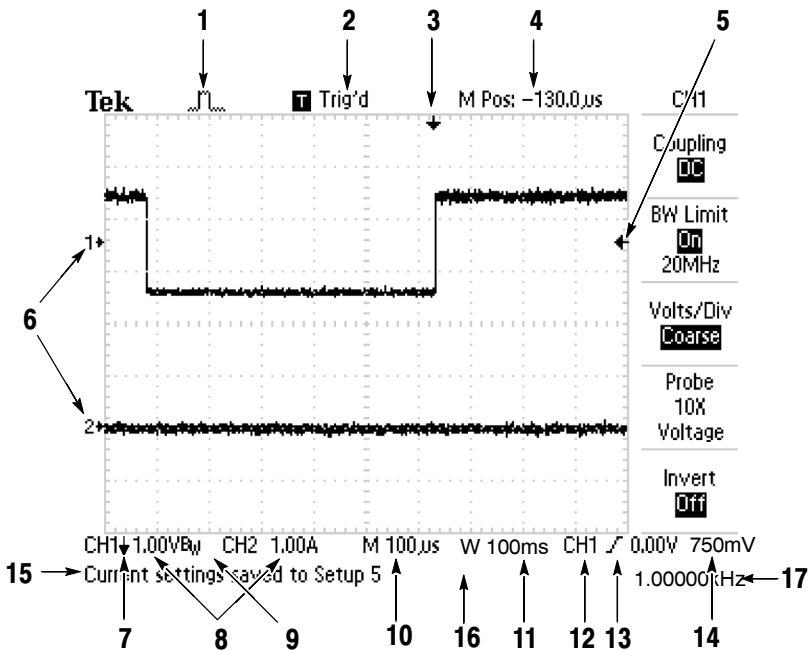

1. Icon display shows acquisition mode.



Sample mode



Peak detect mode



Average mode

2. Trigger status indicates the following:

Armed. The oscilloscope is acquiring pretrigger data. All triggers are ignored in this state.

Ready. All pretrigger data has been acquired and the oscilloscope is ready to accept a trigger.

Trig'd. The oscilloscope has seen a trigger and is acquiring the posttrigger data.

Stop. The oscilloscope has stopped acquiring waveform data.

Acq. Complete. The oscilloscope has completed a Single Sequence acquisition.

Auto. The oscilloscope is in auto mode and is acquiring waveforms in the absence of triggers.

Scan. The oscilloscope is acquiring and displaying waveform data continuously in scan mode.

3. Marker shows horizontal trigger position. Turn the HORIZONTAL POSITION knob to adjust the position of the marker.
4. Readout shows the time at the center graticule. The trigger time is zero.
5. Marker shows Edge or Pulse Width trigger level.

6. On-screen markers show the reference points of the displayed waveforms. If there is no marker, the channel is not displayed.
7. An arrow icon indicates that the waveform is inverted.
8. Readouts show the vertical scale factors of the channels.
9. A B_W icon indicates that the channel is bandwidth limited.
10. Readout shows main time base setting.
11. Readout shows window time base setting if it is in use.
12. Readout shows trigger source used for triggering.
13. Icon shows selected trigger type as follows:

 - Edge trigger for the rising edge.

 - Edge trigger for the falling edge.

 - Video trigger for line sync.

 - Video trigger for field sync.

 - Pulse Width trigger, positive polarity.

 - Pulse Width trigger, negative polarity.

14. Readout shows Edge or Pulse Width trigger level.
15. Display area shows helpful messages; some messages display for only three seconds.

If you recall a saved waveform, readout shows information about the reference waveform, such as RefA 1.00V 500 μ s.

16. Readout shows date and time.
17. Readout shows trigger frequency.

Message Area

The oscilloscope displays a message area (item number 15 in the previous figure) at the bottom of the screen that conveys the following types of helpful information:

- Directions to access another menu, such as when you push the TRIG MENU button:
For TRIGGER HOLDOFF, go to HORIZONTAL Menu
- Suggestion of what you might want to do next, such as when you push the MEASURE button:
Push an option button to change its measurement
- Information about the action the oscilloscope performed, such as when you push the DEFAULT SETUP button:
Default setup recalled
- Information about the waveform, such as when you push the AUTOSET button:
Square wave or pulse detected on CH1

Using the Menu System

The user interface of the oscilloscopes was designed for easy access to specialized functions through the menu structure.

When you push a front-panel button, the oscilloscope displays the corresponding menu on the right side of the screen. The menu shows the options that are available when you push the unlabeled option buttons directly to the right of the screen.

The oscilloscope uses several methods to display menu options:

- **Page (Submenu) Selection:** For some menus, you can use the top option button to choose two or three submenus. Each time you push the top button, the options change. For example, when you push the top button in the TRIGGER Menu, the oscilloscope cycles through the Edge, Video, and Pulse Width trigger submenus.
- **Circular List:** The oscilloscope sets the parameter to a different value each time you push the option button. For example, you can push the CH 1 MENU button and then push the top option button to cycle through the Vertical (channel) Coupling options.
- **Action:** The oscilloscope displays the type of action that will immediately occur when you push an Action option button. For example, when the Help Index is visible, and you push the Page Down option button, the oscilloscope immediately displays the next page of index entries.

- Radio:** The oscilloscope uses a different button for each option. The currently-selected option is highlighted. For example, the oscilloscope displays various acquisition mode options when you push the ACQUIRE Menu button. To select an option, push the corresponding button.

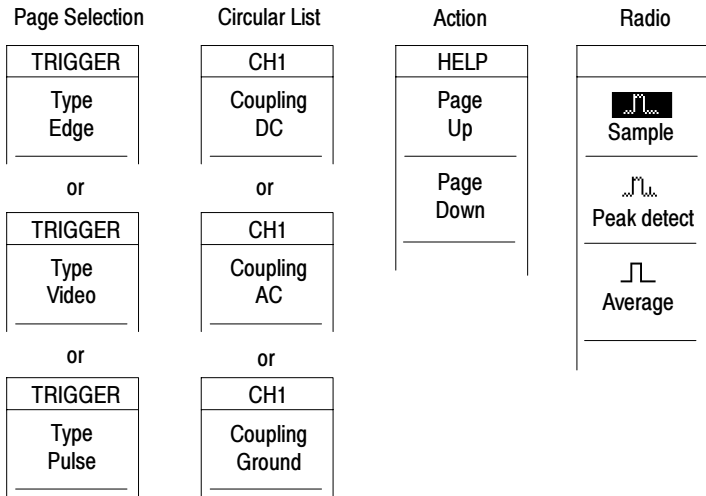

Vertical Controls

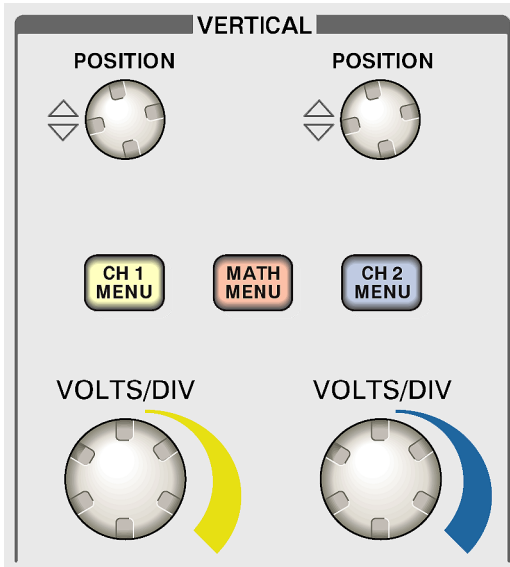

All models

POSITION (CH 1, CH 2, CH 3, & CH 4). Positions a waveform vertically.

CH 1, CH 2, CH 3 & CH 4 MENU. Displays the vertical menu selections and toggles the display of the channel waveform on and off.

VOLTS/DIV (CH 1, CH 2, CH 3 & CH 4). Selects calibrated scale factors.

MATH MENU. Displays waveform math operations menu and toggles the display of the math waveform on and off.

Horizontal Controls

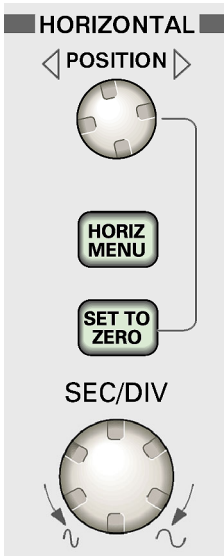

2-channel model

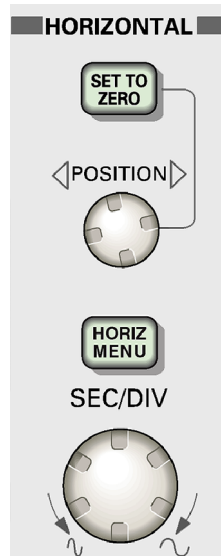

4-channel models

POSITION. Adjusts the horizontal position of all channel and math waveforms. The resolution of this control varies with the time base setting. For information on windows, refer to page 9-23.

NOTE. To make a large adjustment to the horizontal position, turn the SEC/DIV knob to a larger value, change the horizontal position, and then turn the SEC/DIV knob back to the previous value.

HORIZ MENU. Displays the Horizontal Menu.

SET TO ZERO. Sets the horizontal position to zero.

SEC/DIV. Selects the horizontal time/div (scale factor) for the main or the window time base. When **Window Zone** is enabled, it changes the width of the window zone by changing the window time base. Refer to page 9-23 for details about creating and using Window Zone.

Trigger Controls

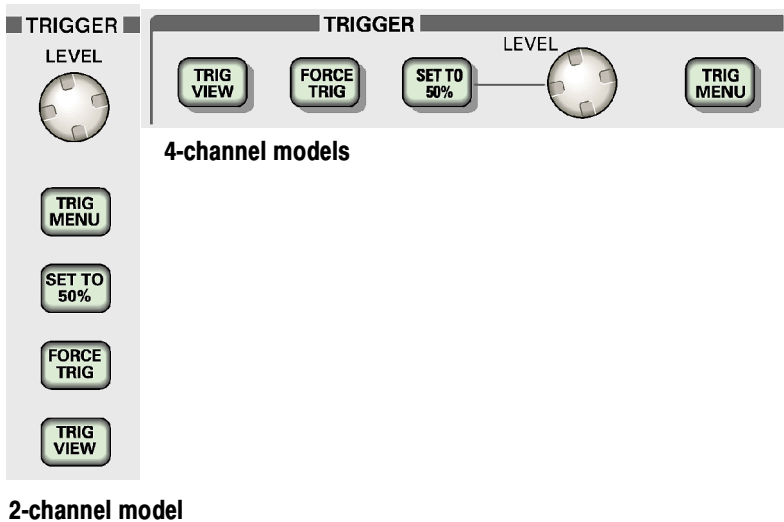

LEVEL. When you use an Edge or Pulse trigger, the LEVEL knob sets the amplitude level the signal must cross to acquire a waveform.

TRIG MENU. Displays the Trigger Menu.

SET TO 50%. The trigger level is set to the vertical midpoint between the peaks of the trigger signal.

FORCE TRIG. Completes an acquisition regardless of an adequate trigger signal. This button has no effect if the acquisition is already stopped.

TRIG VIEW. Displays the trigger waveform in place of the channel waveform while you hold down the TRIG VIEW button. Use this to see how the trigger settings affect the trigger signal, such as trigger coupling.

Menu and Control Buttons

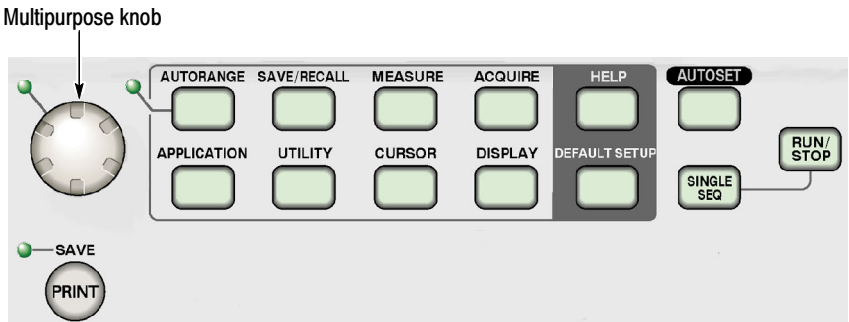

Refer to the *Reference* chapter for detailed information on the menu and button controls.

Multipurpose Knob. Function is determined by the displayed menu or selected menu option. When active, the adjacent LED lights.

Active menu or option	Knob function	Description
Cursor	Cursor 1 or Cursor 2	Positions the selected cursor
Display	Adjust Contrast	Changes the contrast of the display
	Adjust Brightness	Changes the brightness of the display
Help	Scroll	Selects entries in the Index; selects links in a topic; displays the next or previous page for a topic
Horizontal	Holdoff	Sets the amount of time before another trigger event can be accepted; refer to <i>Holdoff</i> on page 9-46
Math	Position	Positions the math waveform
	Vertical Scale	Changes the scale of the math waveform
Save/Recall	File selection	Selects setup or waveform files to save or to recall

Active menu or option	Knob function	Description
Trigger	Video line number	Sets the oscilloscope to a specific line number when the Trigger Type option is set to Video and the Sync option is set to Line Number
	Pulse width	Sets the width of the pulse when the Trigger Type option is set to Pulse
Utility ▶ File Utilities	File selection	Selects files to rename or delete; see page 9-49
	Name entry	Renames the file or folder; see page 9-49
Utility ▶ Options ▶ Set Date and Time	Value entry	Sets the value for the date or time; see page 9-48

AUTORANGE. Displays the Autorange Menu, and activates or deactivates the autoranging function. When autoranging is active, the adjacent LED lights.

SAVE/RECALL. Displays the Save/Recall Menu for setups and waveforms.

MEASURE. Displays the automated measurements menu.

ACQUIRE. Displays the Acquire Menu.

APPLICATION. Displays a menu when an Application Key is inserted in the front of the oscilloscope, for example Power Analysis.

UTILITY. Displays the Utility Menu.

CURSOR. Displays the Cursor Menu. Cursors remain displayed (unless the Type option is set to Off) after leaving the Cursor Menu but are not adjustable.

DISPLAY. Displays the Display Menu.

HELP. Displays the Help Menu.

DEFAULT SETUP. Recalls the factory setup.

AUTOSET. Automatically sets the oscilloscope controls to produce a usable display of the input signals.

SINGLE SEQ. Acquires a single waveform and then stops.

RUN/STOP. Continuously acquires waveforms or stops the acquisition.

PRINT. Starts print operations through the Centronics or RS-232 ports, or performs the SAVE function to the removable mass storage.

SAVE. An LED indicates when the PRINT button is configured to save data to the CF card.

Input Connectors

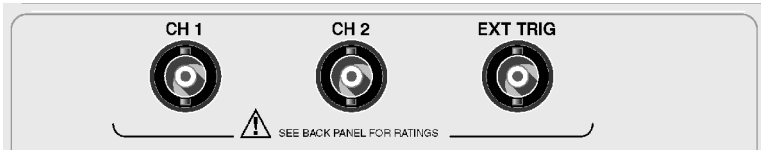

2-channel model

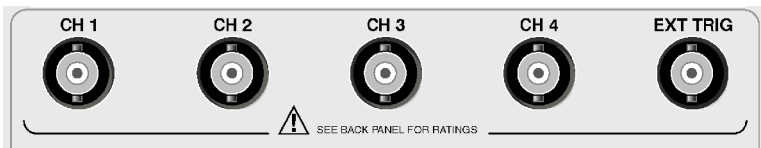

4-channel models

CH 1, CH 2, CH 3 & CH 4. Input connectors for waveform display.

EXT TRIG. Input connector for an external trigger source. Use the Trigger Menu to select the Ext, Ext/5, or Ext/10 trigger source. Push and hold the TRIG VIEW button to see how the trigger settings affect the trigger signal, such as trigger coupling.

Other Front-Panel Items

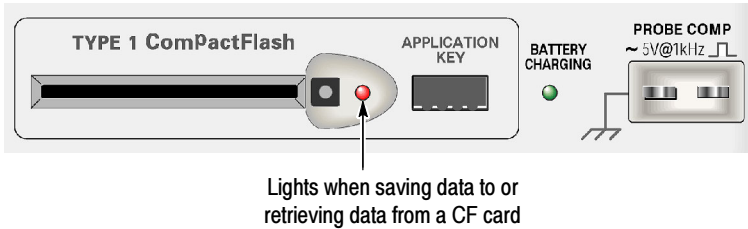

TYPE 1 CompactFlash. Insert a CompactFlash (CF) card for removable memory storage. When saving data to or retrieving data from a CF card, the adjacent LED lights. Wait until the LED goes out to remove the card.

APPLICATION KEY. Insert an Application Key to enable an optional application, such as for power analysis.

BATTERY CHARGING. An LED indicates when the oscilloscope is charging installed battery packs.

PROBE COMP. Probe compensation output and chassis reference. Use to electrically match a voltage probe to the oscilloscope input circuit. See page 1-17.

The probe compensation reference lead connects to earth ground and is then considered to be a ground terminal when using the oscilloscope AC adaptor. See page 1-4.



CAUTION. *When using the DC adapter, do not connect a voltage source to any exposed metal as this may damage the oscilloscope or the circuit under test.*



Understanding Oscilloscope Functions

Understanding Oscilloscope Functions

This chapter contains general information on what you need to understand before you use an oscilloscope. To use your oscilloscope effectively, you need to learn about the following functions:

- Setting up the oscilloscope
- Triggering
- Acquiring signals (waveforms)
- Scaling and positioning waveforms
- Measuring waveforms

The figure below shows a block diagram of the various functions of the oscilloscope and their relationship to each other.

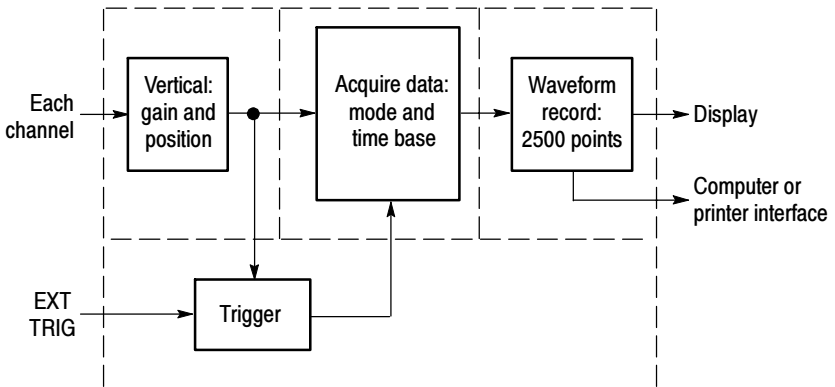

Setting Up the Oscilloscope

You should become familiar with several functions that you may use often when operating your oscilloscope: Autoset, Autorange, saving a setup, and recalling a setup.

Using Autoset

Autoset functions one time each time you push the AUTOSET button. The function obtains a stable waveform display for you. It automatically adjusts the vertical scale, horizontal scale and trigger settings. Autoset also displays several automatic measurements in the graticule area, depending on the signal type.

Using Autorange

Autorange is a continuous function that you can enable or disable. The function adjusts setup values to track a signal when the signal exhibits large changes or when you physically move the probe to a different point.

Saving a Setup

The oscilloscope saves the current setup if you wait five seconds after the last change before you power off the oscilloscope. The oscilloscope recalls this setup the next time you apply power.

You can use the SAVE/RECALL Menu to permanently save up to ten different setups.

You can also save setups to the CompactFlash card. The oscilloscope accommodates a Type 1 CompactFlash card for removable mass storage. See page 7-1.

Recalling a Setup

The oscilloscope can recall the last setup before the oscilloscope was powered off, any saved setups, or the default setup. See page 9-28.

Default Setup

The oscilloscope is set up for normal operation when it is shipped from the factory. This is the default setup. To recall this setup, push the DEFAULT SETUP button. To view the default settings, refer to *Appendix D: Default Setup*.

Triggering

The trigger determines when the oscilloscope starts to acquire data and display a waveform. When a trigger is set up properly, the oscilloscope converts unstable displays or blank screens into meaningful waveforms.

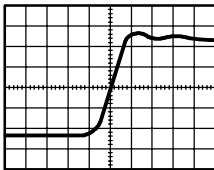

Triggered waveform

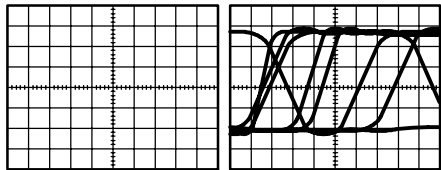

Untriggered waveforms

For oscilloscope-specific descriptions, refer to page 2-10 in the *Operating Basics* chapter and page 9-36 in the *Reference* chapter.

When you push the RUN/STOP or SINGLE SEQ button to start an acquisition, the oscilloscope goes through the following steps:

1. Acquires enough data to fill the portion of the waveform record to the left of the trigger point. This is called the pretrigger.
2. Continues to acquire data while waiting for the trigger condition to occur.
3. Detects the trigger condition.
4. Continues to acquire data until the waveform record is full.
5. Displays the newly-acquired waveform.

NOTE. *For Edge and Pulse triggers, the oscilloscope counts the rate at which trigger events occur to determine trigger frequency and displays the frequency in the lower right corner of the screen.*

Source

You can use the Trigger Source options to select the signal that the oscilloscope uses as a trigger. The source can be any signal connected to a channel BNC, or to the EXT TRIG BNC.

Types

The oscilloscope provides three types of triggers: Edge, Video, and Pulse Width.

Modes

You can select the Auto or the Normal trigger mode to define how the oscilloscope acquires data when it does not detect a trigger condition. See page 9-38.

To perform a single sequence acquisition, push the SINGLE SEQ button.

Coupling

You can use the Trigger Coupling option to determine which part of the signal will pass to the trigger circuit. This can help you attain a stable display of the waveform.

To use trigger coupling, push the TRIG MENU button, select an Edge or Pulse trigger, and select a Coupling option.

NOTE. *Trigger coupling affects only the signal passed to the trigger system. It does not affect the bandwidth or coupling of the signal displayed on the screen.*

To view the conditioned signal being passed to the trigger circuit, push and hold down the TRIG VIEW button.

Position

The horizontal position control establishes the time between the trigger and the screen center. Refer to *Horizontal Scale and Position; Pretrigger Information* on page 3-8 for more information on how to use this control to position the trigger.

Slope and Level

The Slope and Level controls help to define the trigger. The Slope option (Edge trigger type only) determines whether the oscilloscope finds the trigger point on the rising or the falling edge of a signal. The TRIGGER LEVEL knob controls where on the edge the trigger point occurs.

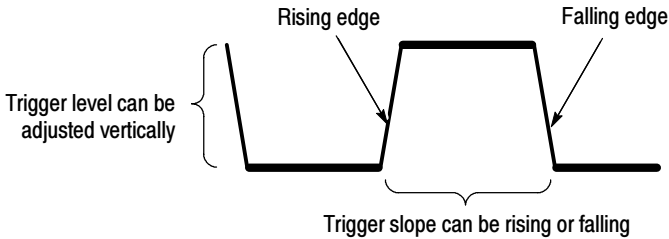

Acquiring Signals

When you acquire a signal, the oscilloscope converts it into a digital form and displays a waveform. The acquisition mode defines how the signal is digitized and the time base setting affects the time span and level of detail in the acquisition.

Acquisition Modes

There are three acquisition modes: Sample, Peak Detect, and Average.

Sample. In this acquisition mode, the oscilloscope samples the signal in evenly spaced intervals to construct the waveform. This mode accurately represents signals most of the time.

However, this mode does not acquire rapid variations in the signal that may occur between samples. This can result in aliasing (described on page 3-9) and may cause narrow pulses to be missed. In these cases, you should use the Peak Detect mode to acquire data.

Peak Detect. In this acquisition mode, the oscilloscope finds the highest and lowest values of the input signal over each sample interval and uses these values to display the waveform. In this way, the oscilloscope can acquire and display narrow pulses, which may have otherwise been missed in Sample mode. Noise will appear to be higher in this mode.

Average. In this acquisition mode, the oscilloscope acquires several waveforms, averages them, and displays the resulting waveform. You can use this mode to reduce random noise.

Time Base

The oscilloscope digitizes waveforms by acquiring the value of an input signal at discrete points. The time base allows you to control how often the values are digitized.

To adjust the time base to a horizontal scale that suits your purpose, use the SEC/DIV knob.

Scaling and Positioning Waveforms

You can change the waveform display by adjusting the scale and position. When you change the scale, the waveform display will increase or decrease in size. When you change the position, the waveform will move up, down, right, or left.

The channel reference indicator (located on the left of the graticule) identifies each waveform on the display. The indicator points to the reference level of the waveform record.

To view the display area and readouts, refer to page 2-2.

Vertical Scale and Position

You can change the vertical position of waveforms by moving them up or down in the display. To compare data, you can align a waveform above another or you can align waveforms on top of each other.

You can change the vertical scale of a waveform. The waveform display will contract or expand relative to the reference level.

For oscilloscope-specific descriptions, refer to page 2-8 in the *Operating Basics* chapter and page 9-52 in the *Reference* chapter.

Horizontal Scale and Position; Pretrigger Information

You can adjust the HORIZONTAL POSITION control to view waveform data before the trigger, after the trigger, or some of each. When you change the horizontal position of a waveform, you are actually changing the time between the trigger and the center of the display. (This appears to move the waveform to the right or left on the display.)

For example, if you want to find the cause of a glitch in your test circuit, you might trigger on the glitch and make the pretrigger period large enough to capture data before the glitch. You can then analyze the pretrigger data and perhaps find the cause of the glitch.

You change the horizontal scale of all the waveforms by turning the SEC/DIV knob. For example, you might want to see just one cycle of a waveform to measure the overshoot on its rising edge.

The oscilloscope shows the horizontal scale as time per division in the scale readout. Since all active waveforms use the same time base, the oscilloscope only displays one value for all the active channels, except when you use **Window Zone**. For information on how to use the window function, refer to page 9-23.

For oscilloscope-specific descriptions, refer to page 2-9 in the *Operating Basics* chapter and page 9-21 in the *Reference* chapter.

Time Domain Aliasing. Aliasing occurs when the oscilloscope does not sample the signal fast enough to construct an accurate waveform record. When this happens, the oscilloscope displays a waveform with a frequency lower than the actual input waveform, or triggers and displays an unstable waveform.

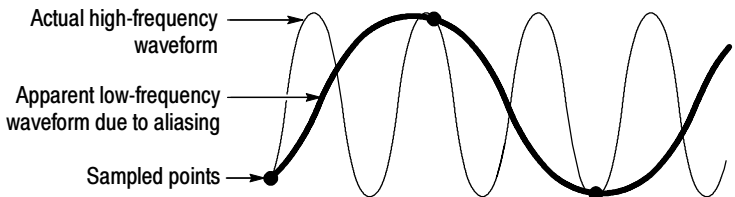

The oscilloscope accurately represents signals, but is limited by the probe bandwidth, the oscilloscope bandwidth, and the sample rate. To avoid aliasing, the oscilloscope must sample the signal more than twice as fast as the highest frequency component of the signal.

The highest frequency that the oscilloscope sampling rate can theoretically represent is the Nyquist frequency. The sample rate is called the Nyquist rate, and is twice the Nyquist frequency.

Oscilloscope models with 100 MHz bandwidth sample at rates up to 1 GS/s. Models with 200 MHz bandwidth sample at rates up to 2 GS/s. In both cases, these maximum sample rates are at least ten times the bandwidth. These high sample rates help reduce the possibility of aliasing.

There are several ways to check for aliasing:

- Turn the SEC/DIV knob to change the horizontal scale. If the shape of the waveform changes drastically, you may have aliasing.
- Select the Peak Detect acquisition mode (described on page 3-7). This mode samples the highest and lowest values so that the oscilloscope can detect faster signals. If the shape of the waveform changes drastically, you may have aliasing.

- If the trigger frequency is faster than the display information, you may have aliasing or a waveform that crosses the trigger level multiple times. Examining the waveform allows you to identify whether the shape of the signal is going to allow a single trigger crossing per cycle at the selected trigger level. If multiple triggers are likely to occur, select a trigger level that will generate only a single trigger per cycle. If the trigger frequency is still faster than the display indicates, you may have aliasing.

If the trigger frequency is slower, this test is not useful.

- If the signal you are viewing is also the trigger source, use the graticule or the cursors to estimate the frequency of the displayed waveform. Compare this to the Trigger Frequency readout in the lower right corner of the screen. If they differ by a large amount, you may have aliasing.

The next table lists the time base settings that you can use to avoid aliasing at various frequencies and the respective sample rate. At the fastest SEC/DIV setting, aliasing is not likely to occur due to the bandwidth limitations of the oscilloscope input amplifiers.

Settings to avoid aliasing in Sample mode

Time base (SEC/DIV)	Samples per second	Maximum frequency component
2.5 ns	2 GS/s	200.0 MHz**
5.0 to 250.0 ns	1 GS/s or 2 GS/s*	200.0 MHz**
500.0 ns	500.0 MS/s	200.0 MHz**
1.0 μ s	250.0 MS/s	125.0 MHz**
2.5 μ s	100.0 MS/s	50.0 MHz**
5.0 μ s	50.0 MS/s	25.0 MHz**
10.0 μ s	25.0 MS/s	12.5 MHz**
25.0 μ s	10.0 MS/s	5.0 MHz
50.0 μ s	5.0 MS/s	2.5 MHz
100.0 μ s	2.5 MS/s	1.25 MHz
250.0 μ s	1.0 MS/s	500.0 kHz
500.0 μ s	500.0 kS/s	250.0 kHz

* Depending on the oscilloscope model.

** Bandwidth reduced to 6 MHz with a P2220 probe set to 1X.

Settings to avoid aliasing in Sample mode (Cont.)

Time base (SEC/DIV)	Samples per second	Maximum frequency component
1.0 ms	250.0 kS/s	125.0 kHz
2.5 ms	100.0 kS/s	50.0 kHz
5.0 ms	50.0 kS/s	25.0 kHz
10.0 ms	25.0 kS/s	12.5 kHz
25.0 ms	10.0 kS/s	5.0 kHz
50.0 ms	5.0 kS/s	2.5 kHz
100.0 ms	2.5 kS/s	1.25 kHz
250.0 ms	1.0 kS/s	500.0 Hz
500.0 ms	500.0 S/s	250.0 Hz
1.0 s	250.0 S/s	125.0 Hz
2.5 s	100.0 S/s	50.0 Hz
5.0 s	50.0 S/s	25.0 Hz
10.0 s	25.0 S/s	12.5 Hz
25.0 s	10.0 S/s	5.0 Hz
50.0 s	5.0 S/s	2.5 Hz

Taking Measurements

The oscilloscope displays graphs of voltage versus time and can help you to measure the displayed waveform.

There are several ways to take measurements. You can use the graticule, the cursors, or an automated measurement.

Graticule

This method allows you to make a quick, visual estimate. For example, you might look at a waveform amplitude and determine that it is a little more than 100 mV.

You can take simple measurements by counting the major and minor graticule divisions involved and multiplying by the scale factor.

For example, if you counted five major vertical graticule divisions between the minimum and maximum values of a waveform and knew you had a scale factor of 100 mV/division, then you could easily calculate your peak-to-peak voltage as follows:

$$5 \text{ divisions} \times 100 \text{ mV/division} = 500 \text{ mV.}$$

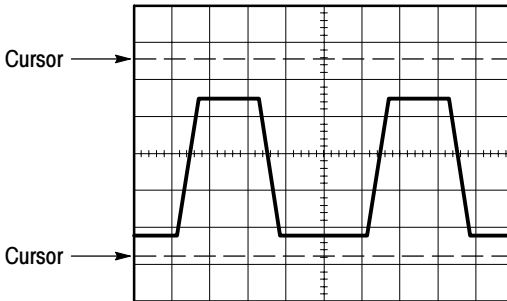

Cursors

This method allows you to take measurements by moving the cursors, which always appear in pairs, and reading their numeric values from the display readouts. There are two types of cursors: Amplitude and Time.

When you use cursors, be sure to set the Source to the waveform on the display that you want to measure.

To use cursors, push the CURSOR button.

Amplitude Cursors. Amplitude cursors appear as horizontal lines on the display and measure the vertical parameters. Amplitudes are referenced to the reference level. For the Math FFT function, these cursors measure magnitude.

Time Cursors. Time cursors appear as vertical lines on the display and measure both horizontal and vertical parameters. Times are referenced to the trigger point. For the Math FFT function, these cursors measure frequency.

Time cursors also include a readout of the waveform amplitude at the point the waveform crosses the cursor.

Automatic

The MEASURE Menu can take up to five automatic measurements. When you take automatic measurements, the oscilloscope does all the calculating for you. Because the measurements use the waveform record points, they are more accurate than the graticule or cursor measurements.

Automatic measurements use readouts to show measurement results. These readouts are updated periodically as the oscilloscope acquires new data.

For measurement descriptions, refer to page 9-25 in the *Reference* chapter.



Application Examples

Application Examples

This section presents a series of application examples. These simplified examples highlight the features of the oscilloscope and give you ideas for using it to solve your own test problems.

- Taking simple measurements
 - Using Autoset
 - Using the Measure Menu to take automatic measurements
 - Measuring two signals and calculating gain
- Using Autorange to examine a series of test points
- Using an isolated channel to analyze a differential communication signal
- Viewing an instantaneous power waveform
- Taking cursor measurements
 - Measuring ring frequency and ring amplitude
 - Measuring pulse width
 - Measuring rise time
- Analyzing signal detail
 - Looking at a noisy signal
 - Using the average function to separate a signal from noise

- Capturing a single-shot signal
Optimizing the acquisition
- Measuring propagation delay
- Triggering on a pulse width
- Triggering on a video signal
Triggering on video fields and video lines
Using the window function to see waveform details
- Viewing impedance changes in a network using XY mode and persistence

Taking Simple Measurements

You need to see a signal in a circuit, but you do not know the amplitude or frequency of the signal. You want to quickly display the signal and measure the frequency, period, and peak-to-peak amplitude.

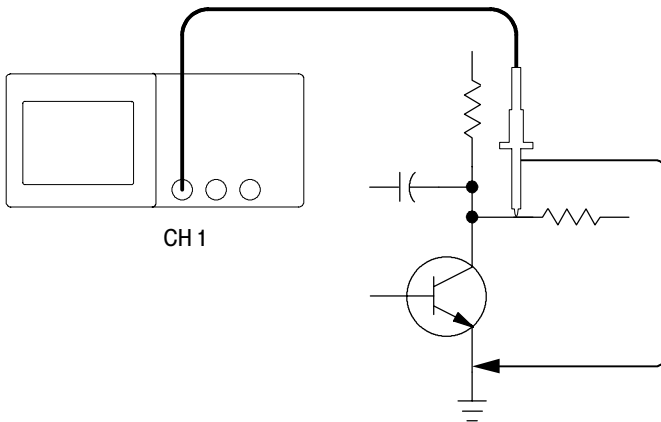

Using Autoset

To quickly display a signal, follow these steps:

1. Push the **CH 1 MENU** button.
2. Push **Probe ▶ Voltage ▶ Attenuation ▶ 10X**.
3. Set the switch to **10X** on the P2220 probe.
4. Connect the channel 1 probe tip to the signal. Connect the reference lead to the circuit reference point.
5. Push the **AUTOSET** button.

The oscilloscope sets the vertical, horizontal, and trigger controls automatically. If you want to optimize the display of the waveform, you can manually adjust these controls.

NOTE. *The oscilloscope displays relevant automatic measurements in the waveform area of the screen based on the signal type detected.*

For oscilloscope-specific descriptions, refer to page 9–10 in the *Reference* chapter.

Taking Automatic Measurements

The oscilloscope can take automatic measurements of most displayed signals. To measure signal frequency, period, and peak-to-peak amplitude, rise time, and positive width, follow these steps:

1. Push the **MEASURE** button to see the Measure Menu.

2. Push the top option button; the Measure 1 Menu appears.

3. Push **Type ▶ Freq.**

The **Value** readout displays the measurement and updates.

NOTE. *If a question mark (?) displays in the Value readout, turn the VOLTS/DIV knob for the appropriate channel to increase the sensitivity or change the SEC/DIV setting.*

4. Push the **Back** option button.

5. Push the second option button from the top; the Measure 2 Menu appears.

6. Push **Type ▶ Period.**

The **Value** readout displays the measurement and updates.

7. Push the **Back** option button.

8. Push the middle option button; the Measure 3 Menu appears.

9. Push **Type ▶ Pk-Pk.**

The **Value** readout displays the measurement and updates.

10. Push the **Back** option button.

11. Push the second option button from the bottom; the Measure 4 Menu appears.

12. Push **Type ▶ Rise Time.**

The **Value** readout displays the measurement and updates.

13. Push the **Back** option button.
14. Push the bottom option button; the Measure 5 Menu appears.
15. Push **Type ▶ Pos Width**.
The **Value** readout displays the measurement and updates.
16. Push the **Back** option button.

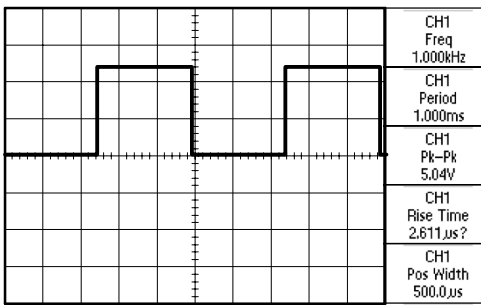

Measuring Two Signals

If you are testing a piece of equipment and need to measure the gain of the audio amplifier, you will need an audio generator that can inject a test signal at the amplifier input. Connect two oscilloscope channels to the amplifier input and output as shown next. Measure both signal levels and use the measurements to calculate the gain.

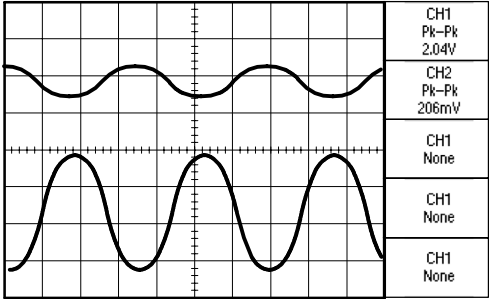
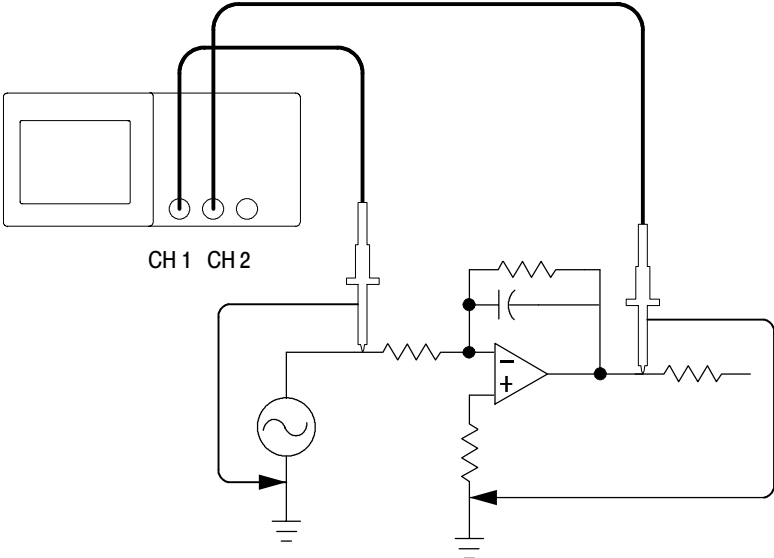

To activate and display the signals connected to channel 1 and to channel 2, and select measurements for the two channels, follow these steps:

1. Push the **AUTOSET** button.
2. Push the **MEASURE** button to see the Measure Menu.
3. Push the top option button; the Measure 1 Menu appears.
4. Push **Source ▶ CH1**.
5. Push **Type ▶ Pk-Pk**.
6. Push the **Back** option button.
7. Push the second option button from the top; the Measure 2 Menu appears.
8. Push **Source ▶ CH2**.
9. Push **Type ▶ Pk-Pk**.
10. Push the **Back** option button.

Read the displayed peak-to-peak amplitudes for both channels.

11. To calculate the amplifier voltage gain, use these equations:

$$\text{VoltageGain} = \frac{\text{output amplitude}}{\text{input amplitude}}$$

$$\text{VoltageGain (dB)} = 20 \times \log_{10}(\text{VoltageGain})$$

Using Autorange to Examine a Series of Test Points

If you have a machine that is malfunctioning, you may need to find the frequency and RMS voltage of several test points, and compare these values to ideal values. You are not able to access front-panel controls since you need to use both hands when probing test points that are difficult to physically reach.

1. Push the **CH 1 MENU** button.
2. Push **Probe ▶ Voltage ▶ Attenuation** and set to match the attenuation of the probe attached to channel 1.
3. Push the **AUTORANGE** button to activate autoranging.
4. Push the **MEASURE** button to see the Measure Menu.
5. Push the top option button; the Measure 1 Menu appears.
6. Push **Source ▶ CH1**.
7. Push **Type ▶ Frequency**.
8. Push the **Back** option button.
9. Push the second option button from the top; the Measure 2 Menu appears.
10. Push **Source ▶ CH1**.
11. Push **Type ▶ Cyc RMS**.

12. Push the **Back** option button.
13. Attach the probe tip and reference lead to the first test point. Read the frequency and cycle RMS measurements from the oscilloscope display and compare these to the ideal values.
14. Repeat step 13 for each test point, until you find the malfunctioning component.

NOTE. *When Autorange is active, each time you move the probe to another test point, the oscilloscope readjusts the horizontal scale, the vertical scale, and the trigger level, to give you a useful display.*

Using an Isolated Channel to Analyze a Differential Communication Signal

You are having intermittent problems with a serial data communication link, and you suspect poor signal quality. Set up the oscilloscope to show you a snapshot of the serial data stream so you can verify the signal levels and transition times.

This is a differential signal. Because the oscilloscope has isolated channels, you can view the signal with a single probe.



WARNING. *Do not float the P2220 probe reference lead to > 30 V_{RMS}. Use the P5120 (floatable to 600 V_{RMS} CAT II or 300 V_{RMS} CAT III) or similarly rated, passive, high voltage probe or an appropriately rated, high voltage, differential probe when floating the reference lead above 30 V_{RMS}, subject to the ratings of such high voltage probe.*

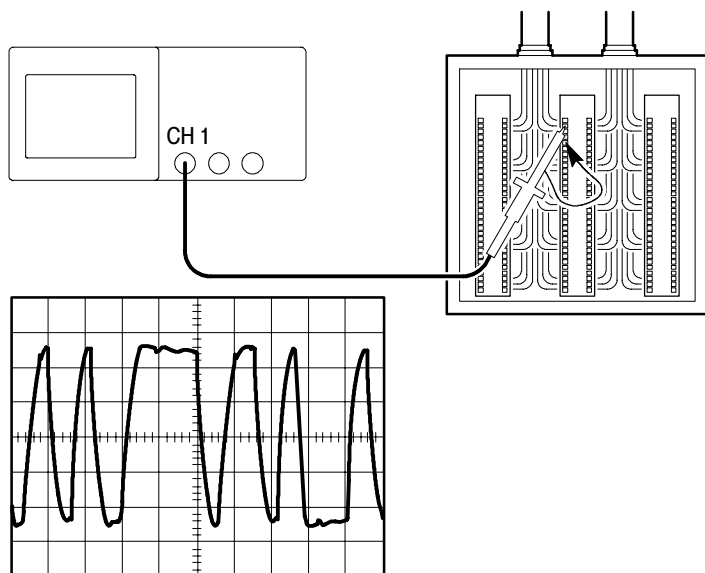

To view the differential signal, follow these steps:

1. Connect the probe tip to one side of the signal.
2. Connect the probe reference lead to the other side of the signal.
3. Push the **AUTOSET** button.

For a more stable display, push the **SINGLE SEQ** button to control the acquisition of the waveform. Each time you push the button, the oscilloscope acquires a snapshot of the digital data stream. You can use the cursors or automatic measurements to analyze the waveform, or you can store the waveform to analyze later.

Viewing a Math Instantaneous Power Waveform

You can use a voltage probe, a current probe, and the oscilloscope math multiply function to view an instantaneous power waveform.

NOTE. Be sure to understand the rating of the voltage or current probes you are using. Do not exceed the probe rating. See page 1-5.

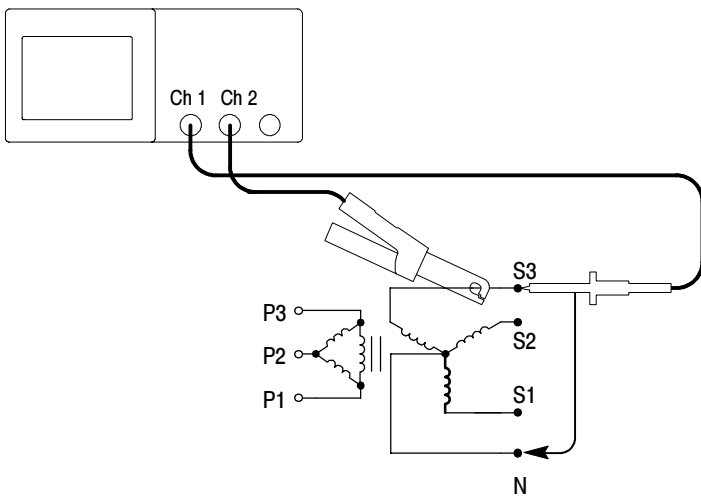

To view a math instantaneous power waveform, follow these steps:

1. Connect a voltage probe to channel 1, and a current probe to channel 2.



WARNING. Do not float the P2220 probe reference lead to $> 30 V_{RMS}$. Use the P5120 (floatable to $600 V_{RMS}$ CAT II or $300 V_{RMS}$ CAT III) or similarly rated, passive, high voltage probe or an appropriately rated, high voltage, differential probe when floating the reference lead above $30 V_{RMS}$, subject to the ratings of such high voltage probe.

2. Push the **CH 1 MENU** button.
3. Push **Probe** ▶ **Voltage** ▶ **Attenuation** and set to match the attenuation of the voltage probe.
4. Push the **CH 2 MENU** button.
5. Push **Probe** ▶ **Current** ▶ **Scale** and set to match the scale of the current probe.
6. Push the **AUTOSET** button.
7. Push **MATH MENU** ▶ **Operation** ▶ \times (multiply).
8. Push **Sources** ▶ **CH1** \times **CH2**.

NOTE. The vertical units of the instantaneous power waveform are VA.

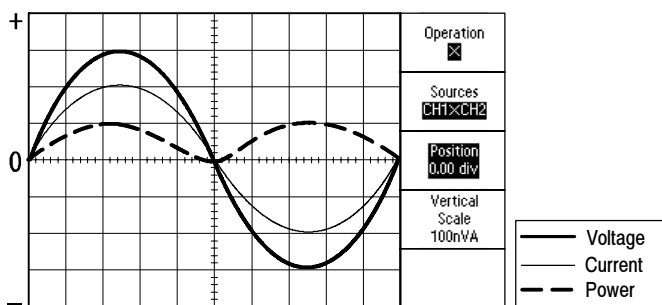

9. To obtain a better view of the Math instantaneous power waveform, you can use the following oscilloscope functions:
 - From the **Math** menu, push the **Position** option button and turn the multipurpose knob to adjust the vertical position
 - From the **Math** menu, push the **Vertical Scale** option button and turn the multipurpose knob to adjust the vertical scale
 - Turn the **SEC/DIV** knob to adjust the horizontal scale
 - Push the **CH 1 MENU** and **CH 2 MENU** buttons to remove the channel waveforms from the display

Taking Cursor Measurements

You can use the cursors to quickly take time and amplitude measurements on a waveform.

Measuring Ring Frequency and Amplitude

To measure the ring frequency at the rising edge of a signal, follow these steps:

1. Push the **CURSOR** button to see the Cursor Menu.
2. Push **Type** ▶ **Time**.
3. Push **Source** ▶ **CH1**.
4. Push the **Cursor 1** option button.
5. Turn the multipurpose knob to place a cursor on the first peak of the ring.

6. Push the **Cursor 2** option button.
7. Turn the multipurpose knob to place a cursor on the second peak of the ring.

You can see the Δ (delta) time and frequency (the measured ring frequency) in the Cursor Menu.

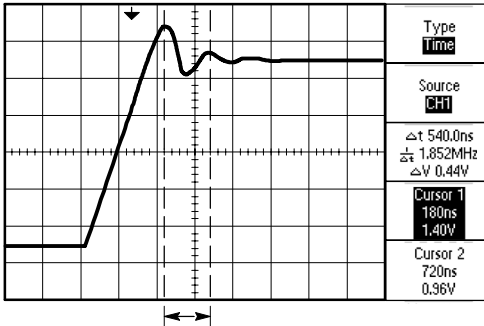

8. Push **Type** \blacktriangleright **Amplitude**.
9. Push the **Cursor 1** option button.
10. Turn the multipurpose knob to place a cursor on the first peak of the ring.
11. Push the **Cursor 2** option button.
12. Turn the multipurpose knob to place Cursor 2 on the lowest part of the ring.

You can see the amplitude of the ring in the Cursor Menu.

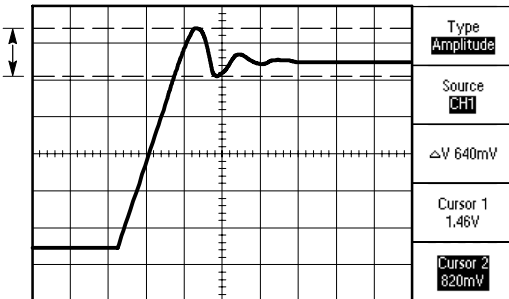

Measuring Pulse Width

If you are analyzing a pulse waveform and you want to know the width of the pulse, follow these steps:

1. Push the **CURSOR** button to see the Cursor Menu.
2. Push **Type** ▶ **Time**.
3. Push **Source** ▶ **CH1**.
4. Push the **Cursor 1** option button.
5. Turn the multipurpose knob to place a cursor on the rising edge of the pulse.
6. Push the **Cursor 2** option button.
7. Turn the multipurpose knob to place a cursor on the falling edge of the pulse.

You can see the following measurements in the Cursor Menu:

- The time at Cursor 1, relative to the trigger.
- The time at Cursor 2, relative to the trigger.
- The Δ (delta) time, which is the pulse width measurement.

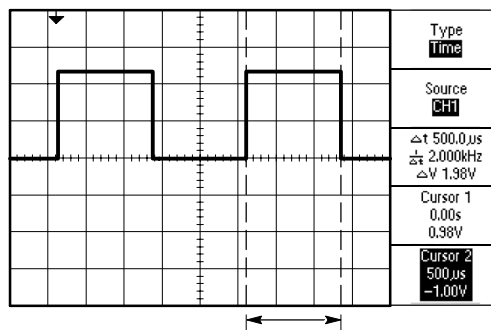

NOTE. The Positive Width measurement is available as an automatic measurement in the Measure Menu, described on page 9-25.

The Positive Width measurement also displays when you select the Single-Cycle Square option in the AUTOSSET Menu. See page 9-13.

Measuring Rise Time

After measuring the pulse width, you decide that you need to check the rise time of the pulse. Typically, you measure rise time between the 10% and 90% levels of the waveform. To measure the rise time, follow these steps:

1. Turn the **SEC/DIV** knob to display the rising edge of the waveform.
2. Turn the **VOLTS/DIV** and **VERTICAL POSITION** knobs to set the waveform amplitude to about five divisions.
3. Push the **CH 1 MENU** button.
4. Push **Volts/Div ▶ Fine**.
5. Turn the **VOLTS/DIV** knob to set the waveform amplitude to exactly five divisions.
6. Turn the **VERTICAL POSITION** knob to center the waveform; position the baseline of the waveform 2.5 divisions below the center graticule.
7. Push the **CURSOR** button to see the Cursor Menu.
8. Push **Type ▶ Time**.
9. Push **Source ▶ CH1**.
10. Push the **Cursor 1** option button.
11. Turn the multipurpose knob to place a cursor at the point where the waveform crosses the second graticule line below center screen. This is the 10% level of the waveform.

12. Push the **Cursor 2** option button.
13. Turn the multipurpose knob to place a cursor at the point where the waveform crosses the second graticule line above center screen. This is the 90% level of the waveform.

The Δt readout in the Cursor Menu is the rise time of the waveform.

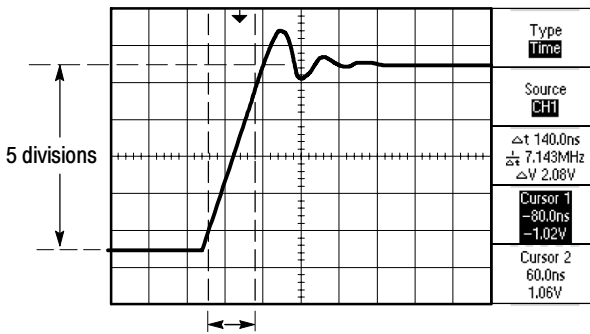

NOTE. The Rise Time measurement is available as an automatic measurement in the Measure Menu, described on page 9-25.

The Rise Time measurement also displays when you select the Rising Edge option in the AUTOSET Menu. Refer to page 9-13.

Analyzing Signal Detail

You have a noisy signal displayed on the oscilloscope and you need to know more about it. You suspect that the signal contains much more detail than you can now see in the display.

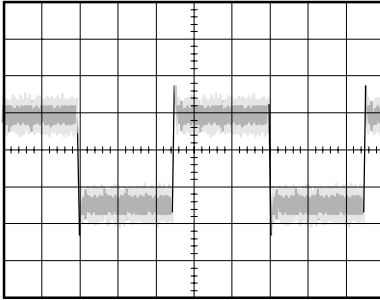

Looking at a Noisy Signal

The signal appears noisy and you suspect that noise is causing problems in your circuit. To better analyze the noise, follow these steps:

1. Push the **ACQUIRE** button to see the Acquire Menu.
2. Push the **Peak Detect** option button.
3. If necessary, push the **DISPLAY** button to see the Display Menu. Use the **Adjust Contrast** and the **Adjust Brightness** option buttons with the multipurpose knob to adjust the display to see the noise more easily.

Peak detect emphasizes noise spikes and glitches in your signal, especially when the time base is set to a slow setting.

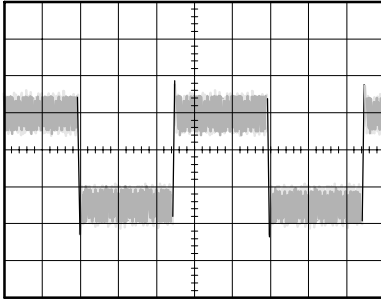

Separating the Signal from Noise

Now you want to analyze the signal shape and ignore the noise. To reduce random noise in the oscilloscope display, follow these steps:

1. Push the **ACQUIRE** button to see the Acquire Menu.
2. Push the **Average** option button.
3. Push the **Averages** option button to see the effects of varying the number of running averages on the waveform display.

Averaging reduces random noise and makes it easier to see detail in a signal. In the example below, a ring shows on the rising and falling edges of the signal when the noise is removed.

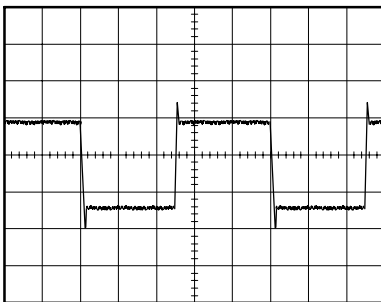

Capturing a Single-Shot Signal

The reliability of a reed relay in a piece of equipment has been poor and you need to investigate the problem. You suspect that the relay contacts arc when the relay opens. The fastest you can open and close the relay is about once per minute so you need to capture the voltage across the relay as a single-shot acquisition.

To set up for a single-shot acquisition, follow these steps:

1. Turn the vertical **VOLTS/DIV** and horizontal **SEC/DIV** knobs to the appropriate ranges for the signal you expect to see.
2. Push the **ACQUIRE** button to see the Acquire Menu.
3. Push the **Peak Detect** option button.
4. Push the **TRIG MENU** button to see the Trigger Menu.
5. Push **Slope ▶ Rising**.
6. Turn the **LEVEL** knob to adjust the trigger level to a voltage midway between the open and closed voltages of the relay.
7. Push the **SINGLE SEQ** button to start the acquisition.

When the relay opens, the oscilloscope triggers and captures the event.

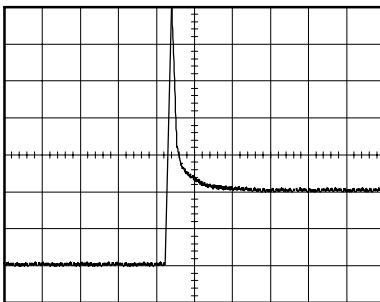

Optimizing the Acquisition

The initial acquisition shows the relay contact beginning to open at the trigger point. This is followed by a large spike that indicates contact bounce and inductance in the circuit. The inductance can cause contact arcing and premature relay failure.

You can use the vertical, horizontal, and trigger controls to optimize the settings before the next single-shot event is captured.

When the next acquisition is captured with the new settings (when you push the SINGLE SEQ button again), you can see more detail about the relay contact opening. You can now see that the contact bounces several times as it opens.

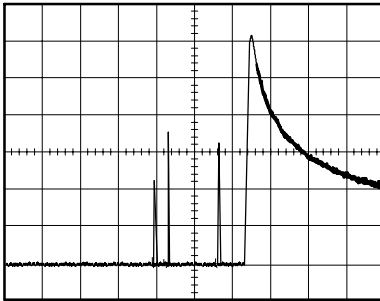

Measuring Propagation Delay

You suspect that the memory timing in a microprocessor circuit is marginal. Set up the oscilloscope to measure the propagation delay between the chip-select signal and the data output of the memory device.

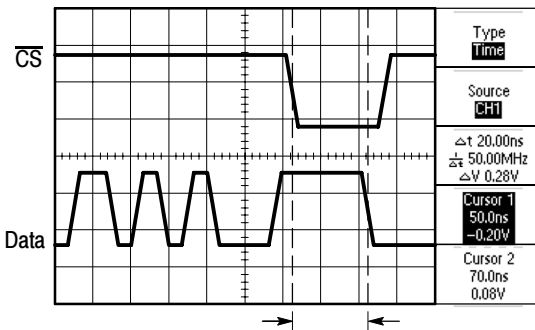
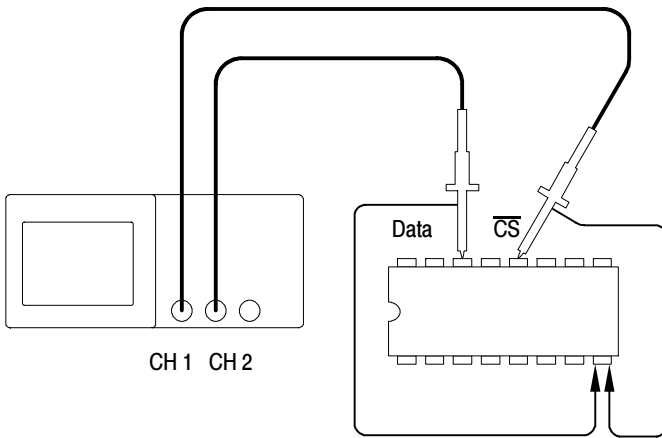

To set up to measure propagation delay, follow these steps:

1. Push the **AUTOSET** button to trigger a stable display.
2. Adjust the horizontal and vertical controls to optimize the display.
3. Push the **CURSOR** button to see the Cursor Menu.
4. Push **Type ▶ Time**.
5. Push **Source ▶ CH1**.
6. Push the **Cursor 1** option button.
7. Turn the multipurpose knob to place a cursor on the active edge of the chip-select signal.
8. Push the **Cursor 2** option button.
9. Turn the multipurpose knob to place the second cursor on the data output transition.

The Δt readout in the Cursor Menu is the propagation delay between the waveforms. The readout is valid because the two waveforms have the same SEC/DIV setting.

Triggering on a Specific Pulse Width

You are testing the pulse widths of a signal in a circuit. It is critical that the pulses all be a specific width and you need to verify that they are. Edge triggering shows that your signal is as specified, and the pulse width measurement does not vary from the specification. However, you think there might be a problem.

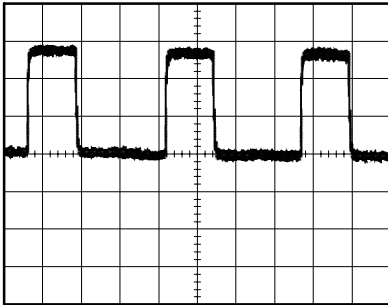

To set up a test for pulse width aberrations, follow these steps:

1. Push the **AUTOSET** button to trigger a stable display.
2. Push the **Single Cycle** option button in the **AUTOSET** Menu to view a single cycle of the signal, and to quickly take a Pulse Width measurement.
3. Push the **TRIG MENU** button to see the Trigger Menu.
4. Push **Type ▶ Pulse**.

5. Push **Source** ▶ **CH1**.
6. Turn the **TRIGGER LEVEL** knob to set the trigger level near the bottom of the signal.
7. Push **When** ▶ = (equals).
8. Turn the multipurpose knob to set the pulse width to the value reported by the Pulse Width measurement in step 2.
9. Push **More** ▶ **Mode** ▶ **Normal**.

You can achieve a stable display with the oscilloscope triggering on normal pulses.

10. Push the **When** option button to select \neq , $<$, or $>$. If there are any aberrant pulses that meet the specified **When** condition, the oscilloscope triggers.

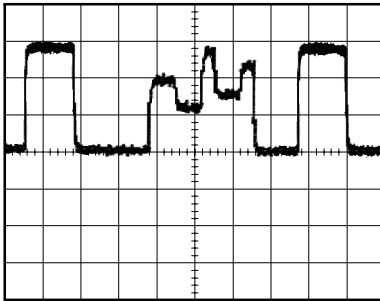

NOTE. *The trigger frequency readout shows the frequency of events the oscilloscope might consider to be a trigger, and may be less than the frequency of the input signal in Pulse Width trigger mode.*

Triggering on a Video Signal

You are testing the video circuit in a piece of medical equipment and need to display the video output signal. The video output is an NTSC standard signal. Use the video trigger to obtain a stable display.

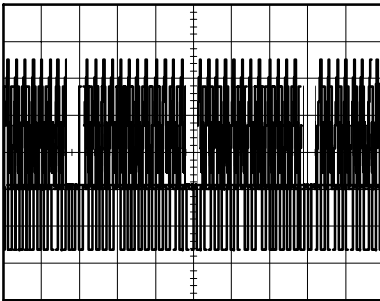
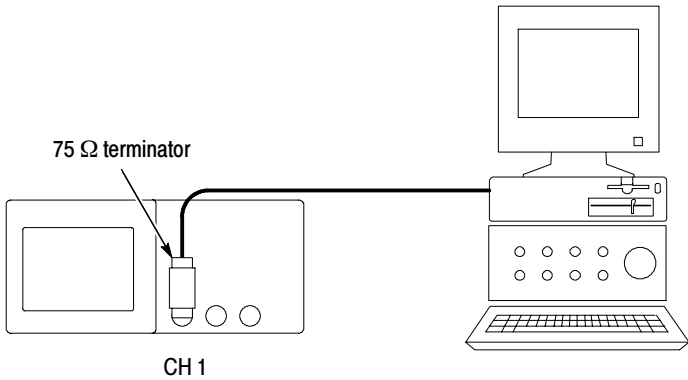

NOTE. Most video systems use 75 ohm cabling. The oscilloscope inputs do not properly terminate low impedance cabling. To avoid amplitude inaccuracy from improper loading and reflections, place a 75 ohm feedthrough terminator (Tektronix part number 011-0055-02 or equivalent) between the 75 ohm coaxial cable from the signal source and the oscilloscope BNC input.

Triggering on Video Fields

Automatic. To trigger on the video fields, follow these steps:

1. Push the **AUTOSET** button. When Autoset is complete, the oscilloscope displays the video signal with sync on **All Fields**.

The oscilloscope sets the Standard option when you use the Autoset function.

2. Push the **Odd Field** or **Even Field** option buttons from the **AUTOSET** Menu to sync on odd or even fields only.

Manual. An alternative method requires more steps, but may be necessary depending on the video signal. To use the manual method, follow these steps:

1. Push the **CH 1 MENU** button.
2. Push **Coupling ▶ AC**.
3. Push the **TRIG MENU** button to see the Trigger Menu.
4. Push the top option button and select **Video**.
5. Push **Source ▶ CH1**.
6. Push the **Sync** option button and select **All Fields**, **Odd Field**, or **Even Field**.

7. Push **Standard ▶ NTSC**.
8. Turn the horizontal **SEC/DIV** knob to see a complete field across the screen.
9. Turn the vertical **VOLTS/DIV** knob to ensure that the entire video signal is visible on the screen.

Triggering on Video Lines

Automatic. You can also look at the video lines in the field. To trigger on the video lines, follow these steps:

1. Push the **AUTOSET** button.
2. Push the top option button to select **Line** to sync on all lines. (The **AUTOSET** Menu includes **All Lines** and **Line Number** options.)

Manual. An alternative method requires more steps, but may be necessary depending on the video signal. To use this method, follow these steps:

1. Push the **TRIG MENU** button to see the Trigger Menu.
2. Push the top option button and select **Video**.
3. Push the **Sync** option button and select **All Lines** or **Line Number** and turn the multipurpose knob to set a specific line number.
4. Push **Standard ▶ NTSC**.
5. Turn the **SEC/DIV** knob to see a complete video line across the screen.
6. Turn the **VOLTS/DIV** knob to ensure that the entire video signal is visible on the screen.

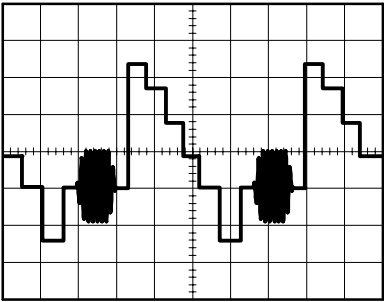
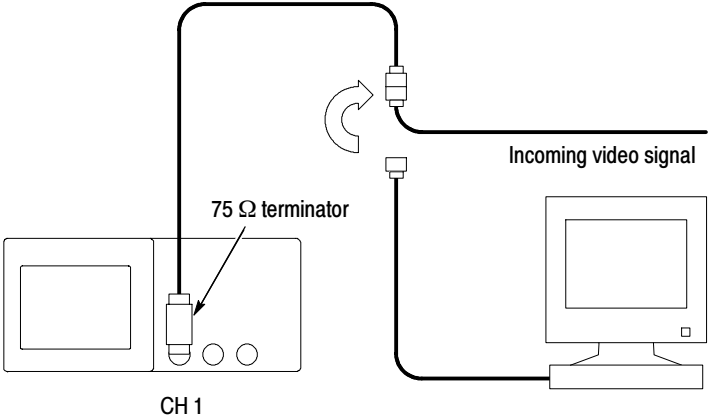

Using the Window Function to See Waveform Details

You can use the window (zoom) function to examine a specific portion of a waveform without changing the main display.

If you want to view the color burst in the previous waveform in more detail without changing the main display, follow these steps:

1. Push the **HORIZ MENU** button to see the Horizontal Menu and select the **Main** option.
2. Push the **Window Zone** option button.
3. Turn the **SEC/DIV** knob and select 500 ns. This will be the **SEC/DIV** setting of the expanded view.
4. Turn the **HORIZONTAL POSITION** knob to position the window around the portion of the waveform that you want to expand.

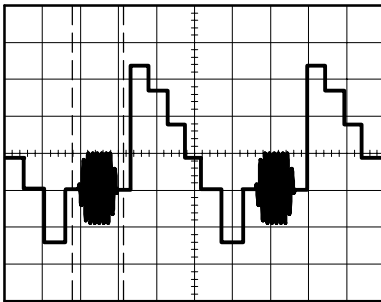

5. Push the **Window** option button to see the expanded portion of the waveform.
6. Turn the **SEC/DIV** knob to optimize viewing the expanded waveform.

To switch between the Main and Window views, push the **Main** or **Window** option button in the Horizontal Menu.

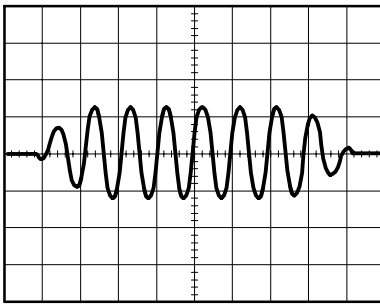

Viewing Impedance Changes in a Network

You have designed a circuit that needs to operate over a wide temperature range. You need to evaluate the change in impedance of the circuit as the ambient temperature is changed.

Connect the oscilloscope to monitor the input and output of the circuit and capture the changes that occur as you vary the temperature.

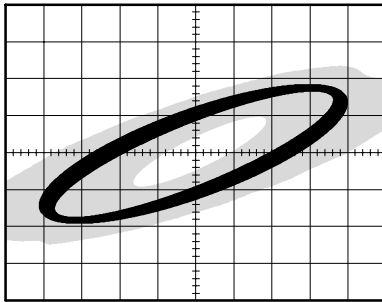
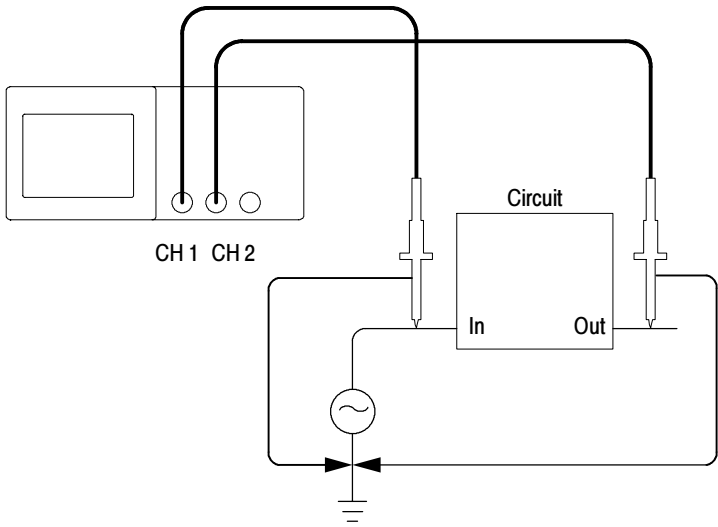

To view the input and output of the circuit in an XY display, follow these steps:

1. Push the **CH 1 MENU** button.
2. Push **Probe ▶ Voltage ▶ Attenuation ▶ 10X**.
3. Push the **CH 2 MENU** button.
4. Push **Probe ▶ Voltage ▶ Attenuation ▶ 10X**.
5. Set the switches to **10X** on the P2220 probes.
6. Connect the channel 1 probe to the input of the network, and connect the channel 2 probe to the output.
7. Push the **AUTOSET** button.
8. Turn the **VOLTS/DIV** knobs to display approximately the same amplitude signals on each channel.
9. Push the **DISPLAY** button to see the Display Menu.
10. Push **Format ▶ XY**.

The oscilloscope displays a Lissajous pattern representing the input and output characteristics of the circuit.

11. Turn the **VOLTS/DIV** and **VERTICAL POSITION** knobs to optimize the display.
12. Push **Persist ▶ Infinite**.
13. Push the **Adjust Contrast** or **Adjust Brightness** option button and turn the multipurpose knob to adjust the display.

As you adjust the ambient temperature, the display persistence captures the changes in the characteristics of the circuit.



Math FFT

Math FFT

This chapter contains detailed information on how to use the Math FFT (Fast Fourier Transform). You can use the FFT Math mode to convert a time-domain (YT) signal into its frequency components (spectrum). You can use the Math FFT mode for the following types of analysis:

- Analyze harmonics in power lines
- Measure harmonic content and distortion in systems
- Characterize noise in DC power supplies
- Test impulse response of filters and systems
- Analyze vibration

To use the Math FFT mode, you need to perform the following tasks:

- Set up the source (time-domain) waveform
- Display the FFT spectrum
- Select a type of FFT window
- Adjust the sample rate to display the fundamental frequency and harmonics without aliasing
- Use zoom controls to magnify the spectrum
- Use cursors to measure the spectrum

NOTE. For viewing the harmonics of power systems, the harmonics feature available with the optional TPS2PWR1 Power Analysis application is optimized for power measurements.

Setting Up the Time-Domain Waveform

Before you use FFT mode, you need to set up the time-domain (YT) waveform. To do so, follow these steps:

1. Push **AUTOSET** to display a YT waveform.
2. Turn the **VERTICAL POSITION** knob to move the YT waveform to the center vertically (zero divisions).

This ensures that the FFT will show a true DC value.

3. Turn the **HORIZONTAL POSITION** knob to position the part of the YT waveform that you want to analyze in the center eight divisions of the screen.

The oscilloscope calculates the FFT spectrum using the center 2048 points of the time-domain waveform.

4. Turn the **VOLTS/DIV** knob to ensure that the entire waveform remains on the screen. The oscilloscope may display erroneous FFT results (by adding high frequency components) if the entire waveform is not visible.
5. Turn the **SEC/DIV** knob to provide the resolution you want in the FFT spectrum.
6. If possible, set the oscilloscope to display many signal cycles.

If you turn the **SEC/DIV** knob to select a faster setting (fewer cycles), the FFT spectrum shows a larger frequency range, and reduces the possibility of FFT aliasing, described on page 5-8. However, the oscilloscope also displays less frequency resolution.

To set up the FFT display, follow these steps:

1. Push the **MATH MENU** button to see the Math Menu.
2. Push **Operation ▶ FFT**.
3. Select the **Math FFT Source** channel.

In many cases, the oscilloscope can produce a useful FFT spectrum even if the YT waveform is not triggered. This is especially true if your signal is periodic or random (noisy).

NOTE. *Trigger transient or burst waveforms and position as close as possible to center screen.*

Nyquist Frequency

The highest frequency that any real-time digitizing oscilloscope can measure without errors is one-half the sample rate. This frequency is called the Nyquist frequency. Frequency information above the Nyquist frequency is undersampled which causes FFT aliasing, described on page 5-8.

The math function transforms the center 2048 points of the time-domain waveform into an FFT spectrum. The resulting FFT spectrum contains 1024 points that go from DC (0 Hz) to the Nyquist frequency.

Normally, the display compresses the FFT spectrum horizontally into 250 points, but you can use the FFT Zoom function to expand the FFT spectrum to more clearly see the frequency components at each of the 1024 data points in the FFT spectrum.

NOTE. *The oscilloscope vertical response rolls off slowly above its bandwidth (100 MHz or 200 MHz, depending on the model, or 20 MHz when the Bandwidth Limit option is set to ON). Therefore, the FFT spectrum can show valid frequency information higher than the oscilloscope bandwidth. However, the magnitude information near or above the bandwidth will not be accurate.*

Displaying the FFT Spectrum

Push the **MATH MENU** button to display the Math Menu. Use the options to select the Source channel, Window algorithm, and FFT Zoom factor. You can display only one FFT spectrum at a time.

Math FFT option	Settings	Comments
Source	CH1 CH2 CH3* CH4*	Selects the channel used as the FFT source
Window	Hanning Flattop Rectangular	Selects the FFT window type; for details, refer to page 5-6
FFT Zoom	X1 X2 X5 X10	Changes the horizontal magnification of the FFT display; for details, refer to page 5-10

* Available only on a 4-channel oscilloscope.

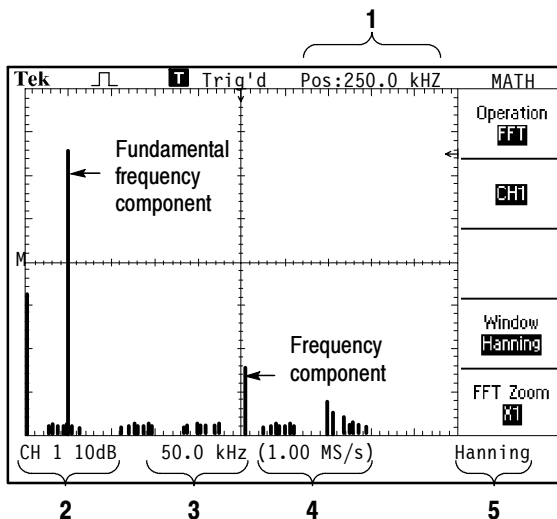

1. Frequency at the center graticule line
2. Vertical scale in dB per division (0 dB = 1 V_{RMS})
3. Horizontal scale in frequency per division
4. Sample rate in number of samples per second
5. FFT window type

Selecting an FFT Window

Windows reduce spectral leakage in the FFT spectrum. The FFT assumes that the YT waveform repeats forever. With an integral number of cycles (1, 2, 3, ...), the YT waveform starts and ends at the same amplitude and there are no discontinuities in the signal shape.

A non-integral number of cycles in the YT waveform causes the signal start and end points to be at different amplitudes. The transitions between the start and end points cause discontinuities in the signal that introduce high-frequency transients.

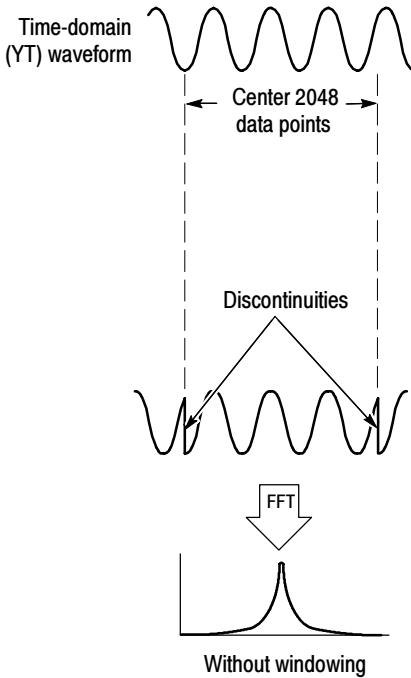

Applying a window to the YT waveform changes the waveform so that the start and stop values are close to each other, reducing the discontinuities.

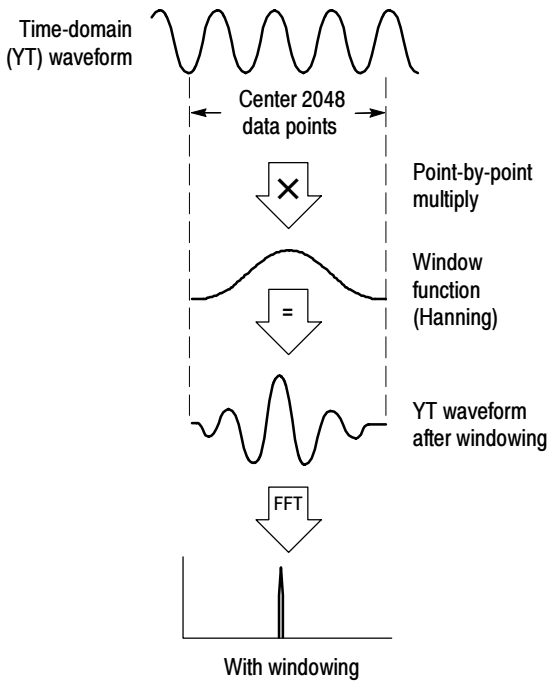

The Math FFT function includes three FFT Window options. There is a trade-off between frequency resolution and amplitude accuracy with each type of window. What you want to measure and your source signal characteristics will help you to determine which window to use.

Window	Measure	Characteristics
Hanning	Periodic waveforms	Better frequency, poorer magnitude accuracy than Flattop
Flattop	Periodic waveforms	Better magnitude, poorer frequency accuracy than Hanning
Rectangular	Pulses or transients	Special-purpose window for waveforms that do not have discontinuities. This is essentially the same as no window

FFT Aliasing

Problems occur when the oscilloscope acquires a time-domain waveform containing frequency components that are greater than the Nyquist frequency (refer to *Nyquist Frequency* on page 5-3). The frequency components that are above the Nyquist frequency are undersampled, appearing as lower frequency components that “fold back” around the Nyquist frequency. These incorrect components are called aliases.

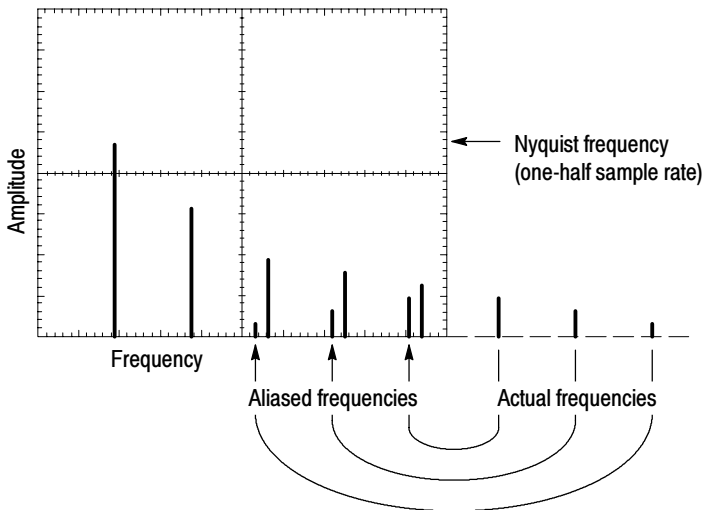

Eliminating Aliases

To eliminate aliases, try the following remedies:

- Turn the **SEC/DIV** knob to set the sample rate to a faster setting. Since you increase the Nyquist frequency as you increase the sample rate, the aliased frequency components appear at their proper frequency. If too many frequency components are shown on the screen, you can use the FFT Zoom option to magnify the FFT spectrum.

- If you do not need to view frequency components above 20 MHz, set the **Bandwidth Limit** option to **On**.
- Put an external filter on the source signal to bandwidth limit the source waveform to frequencies below that of the Nyquist frequency.
- Recognize and ignore the aliased frequencies.
- Use zoom controls and the cursors to magnify and measure the FFT spectrum

Magnifying and Positioning an FFT Spectrum

You can magnify and use cursors to take measurements on the FFT spectrum. The oscilloscope includes an **FFT Zoom** option to magnify horizontally. To magnify vertically, you can use the vertical controls.

Horizontal Zoom and Position

The **FFT Zoom** option lets you horizontally magnify the FFT spectrum without changing the sample rate. Zoom factors are **X1** (default), **X2**, **X5**, and **X10**. At zoom factor **X1**, and with the waveform centered in the graticule, the left graticule line is at 0 Hz and the right graticule line is at the Nyquist frequency.

When you change the zoom factor, the FFT spectrum is magnified about the center graticule line. In other words, the axis of horizontal magnification is the center graticule line.

Turn the **HORIZONTAL POSITION** knob clockwise to move the FFT spectrum to the right. Push the **SET TO ZERO** button to position the center of the spectrum at the center of the graticule.

Vertical Zoom and Position

The channel vertical knobs become vertical zoom and position controls for their respective channels when displaying the FFT spectrum. The VOLTS/DIV knob provides zoom factors of X0.5, X1 (default), X2, X5, and X10. The FFT spectrum is vertically magnified about the M marker (math waveform reference point on the left edge of the screen).

Turn the **VERTICAL POSITION** knob clockwise to move the spectrum up for the source channel.

Measuring an FFT Spectrum Using Cursors

You can take two measurements on FFT spectrums: magnitude (in dB) and frequency (in Hz). Magnitude is referenced to 0 dB, where 0 dB equals $1 V_{RMS}$.

You can use the cursors to take measurements at any zoom factor. To do so, follow these steps:

1. Push the **CURSOR** button to see the Cursor Menu.
2. Push **Source ▶ FFT**.
3. Push the **Type** option button to select between **Magnitude** and **Frequency**.
4. Use the multipurpose knob to move cursors 1 and 2.

Use horizontal cursors to measure magnitude and vertical cursors to measure frequency. The options display the delta between the two cursors, the value at cursor 1 position, and the value at cursor 2 position. Delta is the absolute value of cursor 1 minus cursor 2.

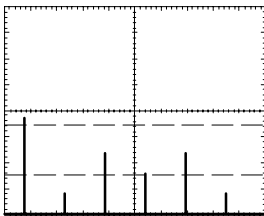

Magnitude cursors

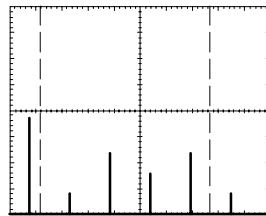

Frequency cursors

You can also take a frequency measurement without using the cursors. To do so, turn the Horizontal Position knob to position a frequency component on the center graticule line and read the frequency at the top right of the display.



Communications (RS-232 and Centronics)

Communications (RS-232 and Centronics)

This chapter describes how to use the communications functions of the oscilloscope and describes how to do the following tasks:

- Send a screen image to an external device (printer or computer)
- Set up and test the RS-232 interface

To use the OpenChoice Desktop software to transfer data from the oscilloscope to a PC, refer to the TDSPCS1 software user manual.



WARNING. Do not float the P2220 probe reference lead to $> 30 V_{RMS}$. Use the P5120 (floatable to $600 V_{RMS}$ CAT II or $300 V_{RMS}$ CAT III) or similarly rated, passive, high voltage probe or an appropriately rated, high voltage, differential probe when floating the reference lead above $30 V_{RMS}$, subject to the ratings of such high voltage probe.

The oscilloscope power-up banner displays a warning message similar to that shown above. The first RS-232 command that the oscilloscope receives will clear this warning message.

Sending a Screen Image to an External Device

The oscilloscope lets you send a screen image to an external device, such as a printer or computer.

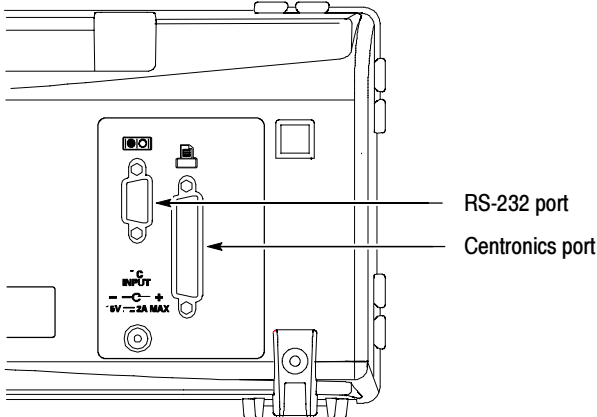

Printer Setup

To set up a printer, follow these steps:

1. Power on the oscilloscope.
2. Push **UTILITY ▶ Options ▶ Printer Setup**.
3. Push the option buttons to change the settings to match those of your printer. The next table lists the settings you can change.

Option	Settings	Comments
PRINT Button	Prints	See page 7-1 for information on other settings
Printer Port	Centronics, RS-232	Communications port used to connect the oscilloscope to a printer or computer
Printer Format*	DPU411, DPU412, DPU3445, Thinkjet, Deskjet, Laser Jet, Bubble Jet, Epson Dot, Epson C60, Epson C80, BMP, PCX, TIFF, RLE, EPSIMAGE	Type of device connected to the communications port or file format
Layout	Portrait, Landscape	Printer output orientation
Ink Saver	On, Off	Prints the screen image on a white background
Abort Printing		Stops sending the screen image to the printer

* **Refer to the www.Tektronix.com/printer_setup web page for a list of compatible printers.**

The next table lists the file formats.

File format	Extension	Comments
BMP	BMP	The default; this bitmap format uses a lossless compression algorithm, and is compatible with most word processing and spreadsheet programs
PCX	PCX	DOS Paintbrush format
TIFF	TIF	Tagged Image File Format
RLE	RLE	Run-length encoding; this format uses a lossless compression algorithm
EPSIMAGE	EPS	Postscript format

NOTE. *The oscilloscope stores these settings until you change them, even if you push the DEFAULT SETUP button.*

If you use the RS-232 port, you also need to set up the parameters for the port appropriately for your printer.

Testing the Printer Port

To test the printer port, follow these steps:

1. If you have already connected the oscilloscope to a printer, go to step 4.
2. Power off the oscilloscope and the printer.
3. Connect the oscilloscope to the printer using the appropriate cable.

4. Power on the oscilloscope and the printer.
5. If you have not done so already, define an appropriate printer setup. Refer to page 6-3.
6. Push the **PRINT** button. The printer begins printing a copy of the oscilloscope screen within twenty seconds, depending on the selected printer.

Printing an Oscilloscope Screen Image

To print a screen image, push the **PRINT** button. The oscilloscope takes a few seconds to capture the screen image. The settings of your printer and print speed determine how long it takes to print the data. Additional time may be required according to the format selected.

NOTE. *You can use the oscilloscope while the printer prints.*

Setting Up and Testing the RS-232 Interface

You may need to set up and test the RS-232 interface. RS-232 is an 8-bit serial communications standard that lets the oscilloscope communicate with an external RS-232 device such as a computer, terminal, or printer. The standard defines two device types: Data Terminal Equipment (DTE) and Data Communications Equipment (DCE). The oscilloscope is a DTE device.

The *RS-232 Connector Pinout Diagram* on page 6-12 shows the pin numbers and signal assignments of the 9-pin RS-232 connector.

Selecting an RS-232 Cable

You need an RS-232 cable to connect the oscilloscope to an external device. Use the next table to choose the correct cable.

To connect the oscilloscope to	Use this type cable	Tektronix part number
PCs with 9-pin serial port connector	9-pin female to 9-pin female, null modem	012-1379-00
PCs with 25-pin serial port connector	9-pin female to 25-pin female, null modem	012-1380-00
Sun workstations, and serial printers, such as an HP Deskjet	9-pin female to 25-pin male, null modem	012-1298-00
Telephone modems	9-pin female to 25-pin male, modem	012-1241-00

Connecting an External Device

When you connect the oscilloscope to an external RS-232 device, follow these guidelines:

- Use the correct cable (refer to the table on page 6-6).
- Use a cable that is no longer than 50 feet (15 meters).
- Power off the oscilloscope and the external device before you connect the cable between them.

NOTE. For information on connecting external devices when making floating measurements refer to Taking Floating Measurements on page 1-4.

RS-232 Settings

To set up the oscilloscope RS-232 interface, follow these steps:

1. Push the **UTILITY** button to see the Utility Menu.
2. Push **Options ▶ RS-232 Setup**.
3. Push the option buttons to match the settings of your external device. The next table lists the settings you can change.

NOTE. *The oscilloscope stores these settings until you change them, even if you push the **DEFAULT SETUP** button.*

Option	Settings	Comments
Set to Defaults		Sets the RS-232 interface to factory defaults (Baud=9600, Flow=hardflagging, EOL String=LF, Parity=None)
Baud	300, 600, 1200, 2400, 4800, 9600, 19200	Sets the data transmission rate
Flow Control	Hardflagging, Softflagging, None	Sets data flow control (Softflagging = Xon/Xoff, Hardflagging = RTS/CTS). Use hardware flagging when you transfer binary data
EOL String	CR, LF, CR/LF, LF/CR	Sets the end-of-line terminator sent by the oscilloscope; the oscilloscope can receive any EOL string
Parity	None, Even, Odd	Adds an error check bit (ninth bit) to each character

NOTE. *When you set the Parity option to None, the oscilloscope uses 8 data bits and 1 stop bit. When you set the Parity option to Even or to Odd, the oscilloscope uses 7 data bits and 1 stop bit.*

You can use the OpenChoice Desktop software included with the oscilloscope to begin transferring information from the oscilloscope to your PC. If the software does not work, then try testing the RS-232 interface.

To test the oscilloscope RS-232 interface, follow these steps:

1. Connect the oscilloscope to a personal computer (PC) using an appropriate RS-232 cable. Refer to the table on page 6-6.
2. Power on the PC.
3. On the PC, run a terminal emulator program, such as Microsoft Windows Hyperterminal. Make sure the PC serial port is set as follows:

Function	Setting
Baud rate	9600
Data flow control	Hardflagging
Parity	None

You also need to set up the terminal emulator program to see characters sent. Enabling echo and CRLF will keep lines from overlapping.

4. Power on the oscilloscope.
5. Push the **UTILITY** button to see the Utility Menu.
6. Push **Options ▶ RS-232 Setup**.
7. Check that the menu settings match those listed in the table on page 6-8.
8. From your PC terminal program, type ID?, then press the Return or Enter key to send the command. The oscilloscope sends back its identification string, which should look similar to the following:

```
ID TEK/TPS 2024,CF:91.1CT,FV:V10.00
```

NOTE. For brief information on command entry, refer to page 6-13.

For complete command information, refer to the TDS200, TDS1000, TDS2000, and TPS2000 Series Digital Oscilloscopes Programmer Manual.

RS-232 Troubleshooting

If the oscilloscope and the external device (computer or printer) have trouble communicating, follow these steps:

1. Check that you are using the correct RS-232 cable. Determine whether your external device requires a null-modem or a straight-through connection. Refer to the table on page 6-6 for information about RS-232 cables.

2. Check that the RS-232 cable is firmly connected to both the oscilloscope and the correct port on the external device.
3. Check that the printer or the program on the personal computer is using the same port to which you connected the RS-232 cable. Try your program or printer again.
4. Check that the oscilloscope RS-232 settings match the settings used by the external device:
 - a. Determine the RS-232 settings for the external device.
 - b. Push the **UTILITY** button to see the Utility Menu.
 - c. Push **► Options ► RS-232 Setup**.
 - d. Set the oscilloscope to match the settings of the external device.
 - e. Try the free Open Choice Desktop software again.
 - f. Try your terminal-emulator program or printer again.
5. Try setting both the oscilloscope and the external device to a slower baud rate.
6. If you receive only part of the printer file, try these remedies:
 - a. Lengthen the timeout for the external device
 - b. Make sure the printer is set to receive a binary file, not a text file.

Transferring Binary Data

To use the RS-232 port to transfer binary data to the oscilloscope, set up the interface as follows:

- Use hardware flagging (RTS/CTS) whenever possible. Hardware flagging guarantees no data loss.
- All eight bits of binary data contain meaningful information. To make sure that all eight bits are received or transmitted, configure the external RS-232 device to receive and transmit eight-bit characters (set the RS-232 word length to eight bits).

Reporting RS-232 I/O Errors

Errors are reported when there is a problem with parity, framing, or input/output buffer overruns. To report errors, the oscilloscope posts an event code. When an error occurs, the oscilloscope discards all input and output and waits for a new command.

Checking Command Status

If you want to check the status of each command sent, append an *STB? query after every command and read the response string.

Processing Break Signals

When the oscilloscope senses a break signal on the RS-232 port, it returns the three character string DCL followed by the end of line terminator. Internally, the oscilloscope acts as if it received a GPIB <DCL> command (device clear), causing the oscilloscope to erase the contents of the input and output buffers and then wait for a new command. Break signals do not change oscilloscope settings or stored data and do not interrupt front-panel operation or nonprogrammable functions.

If a break signal is sent in the middle of a character stream, several characters immediately preceding or following the break can be lost. The controller waits until it receives the three character string DCL and the end of line terminator string before sending more characters.

RS-232 Connector Pinout Diagram

The next figure shows the pin numbering and signal assignments for the RS-232 connector.

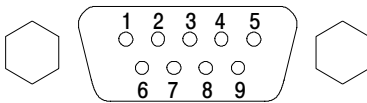

- | | | |
|---|---------------------------|----------|
| 1 | No connection | |
| 2 | Receive data (RxD) | (input) |
| 3 | Transmit data (TxD) | (output) |
| 4 | Data terminal ready (DTR) | (output) |
| 5 | Signal ground (GND) | |
| 6 | Data set ready (DSR) | (input) |
| 7 | Request to send (RTS) | (output) |
| 8 | Clear to send (CTS) | (input) |
| 9 | No connection | |

Command Entry

When you enter oscilloscope commands over the RS-232 bus, follow these general rules:

- You can enter commands in upper or lower case.
- You can abbreviate many oscilloscope commands. These abbreviations are shown in uppercase letters. For example, the command ACQUIRE:NUMAVg can be entered simply as ACQ:NUMAV or acq:numav.
- You can precede any command with white space characters. White space characters include any combination of the ASCII control characters 00 through 09 and 0B through 20 hexadecimal (0 through 9 and 11 through 32 decimal).
- The oscilloscope ignores commands that consist of just a combination of white space characters and line feeds.

Refer to the *TDS200, TDS1000, TDS2000, and TPS2000 Series Digital Oscilloscopes Programmer Manual (071-1075-XX)* for more information.



Removable Mass Storage

Removable Mass Storage

The oscilloscope accommodates a Type 1 CompactFlash (CF) card for removable mass storage. The oscilloscope can save data to and retrieve data from the CF card.

Installing and Removing a CompactFlash (CF) Card

The front of the oscilloscope has a Type 1 CF card slot.

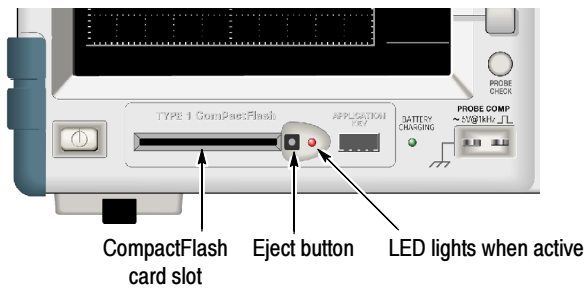

To install a CF card, follow these steps:

1. Align the card with the card slot on the oscilloscope. Type1 cards are keyed.
2. Insert the card into the slot until the card is flush with the front panel. If the card does not easily slide into place, remove it and reinsert it correctly.

To remove a CF card, follow these steps:

1. Push and release the eject button until the button fully extends.
2. Push the eject button again to release the card from the slot.
3. Pull the CF card out of the front-panel slot.

CF Card Initial Read Time

The oscilloscope reads the internal structure of a CF card each time you insert a card. The time to complete the read depends on the size of the CF card and how it is formatted.

To significantly shorten the initial read time of 64 MB and larger CF cards, format the CF card in the oscilloscope.

Formatting a CF Card

The Format function deletes all data on the CF card. To format a CF card, follow these steps:

1. Insert a CF card into the CF card slot.
2. Push the **UTILITY** button to see the Utility Menu.
3. Push **File Utilities** ▶ **More** ▶ **Format**.
4. Select **Yes** to format the CF card.

CF Card Capacities

The oscilloscope can store the following types and number of files per 1 MB of CF card memory:

- 5 Save All operations, described on page 7-4 and page 9-29
- 16 screen image files (capacity depends on the image format), described on page 7-7 and page 9-30
- 250 oscilloscope setting (.SET) files, described on page 9-31
- 18 waveform (.CSV) files, described on page 9-32

File Management Conventions

The oscilloscope uses the following file management conventions for mass storage:

- It checks for available space on the CF card before writing files, and displays a warning message if there is not enough memory available
- The term folder refers to a directory location on the CF card
- The default location for the file save or file recall functions is the current folder
- The root folder is A:\
- The oscilloscope resets the current folder to A:\ when you power on the oscilloscope, or when you insert a CF card after the oscilloscope is powered on

- File names can have one to eight characters, followed by a period, and then followed with an extension of one to three characters
- It displays long file names created on PC operating systems with the shortened file name from the operating system
- File names are upper case

You can use the File Utilities menu to do the following tasks:

- List the contents of the current folder
- Select a file or folder
- Navigate to other folders
- Create, rename, and delete files and folders
- Format the CF card

For details on the UTILITY ▶ File Utilities menu, see page 9-49.

Using the Save function of the PRINT Button

You can change the function of the PRINT button through one of the following options:

- **SAVE/RECALL ▶ Save All ▶ PRINT Button**
- **UTILITY ▶ Options ▶ Printer Setup**

PRINT Button option	Comments
Saves All to Files	Sets the button to save all active oscilloscope information (waveforms, screen image, settings) to files in a new subfolder in the current CF card folder
Saves Image to File	Sets the button to save the screen image to a file on the CF card
Prints	See page 6-3 for information on printer setups

NOTE. An LED by the *PRINT* button lights to indicate the alternative *SAVE* function that writes data to the CF card.

Saves All to Files

This option allows you to save all of the current oscilloscope information to files on the CF card. Before you can save data to the CF card, you need to configure the *PRINT* button to the alternative *SAVE* function. To do so, select **SAVE/RECALL ▶ Save All ▶ PRINT Button ▶ Saves All to Files**.

When you push the **SAVE** button, the oscilloscope creates a new folder on the CF card and saves the information in separate files in that new folder, using the current oscilloscope and file format settings. The oscilloscope names the folder ALLnnnn.

Source	File name
CH(x)	FnnnnCHx.CSV, where nnnn is an automatically-generated number, and x is the channel number
MATH	FnnnnMTH.CSV
Ref(x)	FnnnnRFx.CSV, where x is the reference memory letter
Screen Image	FnnnnTEK.???, where ??? is the current Saves Image to File format
Settings	FnnnnTEK.SET

File type	Contents and uses
.CSV	Contains ASCII text strings that list the time (relative to the trigger) and amplitude values for each of the 2500 waveform data points; you can import .CSV files into many spreadsheet and math analysis applications
Screen images	Import files into spreadsheet and word processing applications; type of image file depends on the application
.SET	Contains an ASCII text string listing of the oscilloscope settings; refer to the <i>TDS200</i> , <i>TDS1000</i> , <i>TDS2000</i> , and <i>TPS2000 Series Digital Oscilloscopes Programmer Manual</i> to decode strings

Saves Image to File

This option allows you to save the oscilloscope screen image to a file named TEKnnnn.???, where .??? is the specified graphics file format. For more information, see page 9-30.

Before you can save data to the CF card, you need to configure the PRINT button to the alternative SAVE function. To do so, select **SAVE/RECALL ▶ Save All ▶ PRINT Button ▶ Saves Image to File.**



Managing TPSBAT Battery Packs

Managing TPSBAT Battery Packs

This section contains information on the following topics:

- Caring for TPSBAT battery packs
- Checking the charge status
- Charging battery packs
- Calibrating battery packs
- Replacing the original battery packs

Caring for Battery Packs

The oscilloscope uses Lithium-Ion (Li-Ion) battery packs designed to last at least two years or 300 charge-discharge cycles. Failure to charge, discharge, or operate a battery pack under conditions recommended in this chapter can shorten battery pack life.

Li-Ion battery packs have an internal circuit that monitors their charge status. When battery packs are not fully discharged or fully charged, the circuit accumulates charge-tracking errors. If the circuit detects accumulated errors of greater than 10%, the oscilloscope reports the battery pack as uncalibrated. An uncalibrated battery pack cannot accurately report its operating capacity.

Although Li-Ion battery packs do not exhibit the memory effects of other battery technologies (NiCad, NiMH), they should still be fully discharged before being recharged. Following this practice maintains battery pack calibration, allowing the oscilloscope to accurately predict the remaining time it can operate.

Continuous Charging

You do not need to continuously charge (trickle charge) Li-Ion battery packs to maintain full operating capacity between jobs. However, a fully charged Li-Ion battery pack can lose up to 10% of its charge during the first month of nonuse. Self-discharge then tapers off in increments of about 5% per month. If you plan to store battery packs long term, read the *Long Term Storage* instructions on page 8-3.

Charging Temperature

Charge the battery packs within an ambient temperature range of 0 to 45 °C (32 to 113 °F). Charging battery packs outside of this range can damage cells or cause them to leak. Charging efficiency is best between 0 and 30 °C (32 and 86 °F) with less than 80% relative humidity.

Discharging Temperature

The battery packs are rated to operate between -10 and +50 °C (-14 and +122 °F) with less than 80% relative humidity. Operating outside of this range can cause damage. Battery discharge capacity drops significantly at temperatures below 0 °C (32 °F) and above 45 °C (113 °F).

Cold temperatures adversely affect the normal electrochemical reactions within a battery pack, reducing the available capacity. Although Li-Ion battery packs can operate down to $-20\text{ }^{\circ}\text{C}$ ($-4\text{ }^{\circ}\text{F}$) without damage, the available capacity is significantly reduced below $0\text{ }^{\circ}\text{C}$ ($32\text{ }^{\circ}\text{F}$). You can minimize this loss by keeping the battery packs warm prior to and during use.

Short Term Storage

Store battery packs in a low-humidity environment free of corrosive gases. The storage temperature needs to range between -40 and $+50\text{ }^{\circ}\text{C}$ (-40 and $+122\text{ }^{\circ}\text{F}$) with less than 80% relative humidity. Storing battery packs in high humidity environments, or outside the temperature range, can rust metallic parts and cause leakage.

Long Term Storage

Store Li-Ion battery packs for one year or longer in a location with a temperature range between 10 and $30\text{ }^{\circ}\text{C}$ (50 and $86\text{ }^{\circ}\text{F}$) with less than 80% relative humidity. It is best to fully discharge battery packs before long term storage. Fully charge and discharge battery packs once a year to prevent internal leakage and deterioration.

Service Life

Because battery packs rely on internal chemical reactions, performance deteriorates not only with use but also during prolonged storage. Improper use can shorten battery pack life or reduce performance.

Oscilloscope functions, such as saving data to a CF card, number of channels used, and display brightness, have little effect on battery pack life.

NOTE. *Significantly reduced capacity, despite proper charging and discharging, indicates the end of battery pack life.*

Li-Ion battery packs must be disposed of properly. See page xvi for battery pack disposal and recycling information.

Transportation Information

Regulations regarding transportation of Li-Ion (lithium-ion) battery packs on passenger aircraft may subject this product to special handling restrictions. Consult your air carrier for applicability and determination of any special Li-Ion battery pack transportation requirements. The TPSBAT lithium-ion battery pack contains less than 8 grams of lithium, with individual cells each containing less than 1.5 grams of lithium as measured by International Civil Aviation Organization (ICAO) standards.

Checking the Charge and Calibration Status

The **UTILITY ▶ System Status ▶ Misc** option shows the amount of time you can continue to operate the oscilloscope from the battery packs and the battery charge status. If the oscilloscope is operating from the AC adaptor, only the battery charge status is reported.

The remaining time calculation is based on a one minute running average of the current drain for the battery pack in use. Wait at least one minute after you power on the oscilloscope to ensure an accurate reading.

Charging Battery Packs

You can charge the battery packs in an oscilloscope or in the external battery charger.

Charge method	Amount of time to charge per battery
Oscilloscope (internal)	With the oscilloscope power ON, 7 hours
	With the oscilloscope power OFF, 4.5 hours
External	3 hours



WARNING. Do not attempt to charge a battery pack below 0°C (32°F) or above 45°C (113°F). Charging a battery pack outside of this range can damage the battery pack and will result in a partial charge.

Internal Charge

The oscilloscope has a built-in charge system that can charge internal battery packs while the AC adaptor is connected. A fully discharged battery pack requires approximately 4.5 hours to fully charge if the oscilloscope is powered down. If the oscilloscope is operating, a battery pack can take up to 7 hours to fully charge.

If the oscilloscope has two battery packs installed, it will charge the battery pack with the highest available capacity first, until fully charged. It will then charge the second battery pack.

Likewise, if the oscilloscope has two battery packs installed, it will operate from the battery pack with the lowest available capacity until it reaches full discharge. The oscilloscope will then operate from the second battery pack until it reaches full discharge.

To charge a battery pack in the oscilloscope, follow these steps:

1. Place the battery pack in the battery compartment. See page 1-8 for instructions.
2. Apply external power from the oscilloscope AC adaptor. The green, BATTERY CHARGING indicator on the front panel lights and the battery pack begins to charge immediately.

External Charge

You can use the optional TPSCHG battery charger (see *Optional Accessories*, page B-2) to externally charge battery packs. For complete information, refer to the manual for the external charger.

To use the external charger, follow these steps:

1. Place up to two battery packs in the charger slots. Battery packs are keyed, so you can insert them only one way.
2. The battery packs begin to charge immediately.

LEDs indicate which battery pack is being charged, the status of the charge, and when the charge is complete.

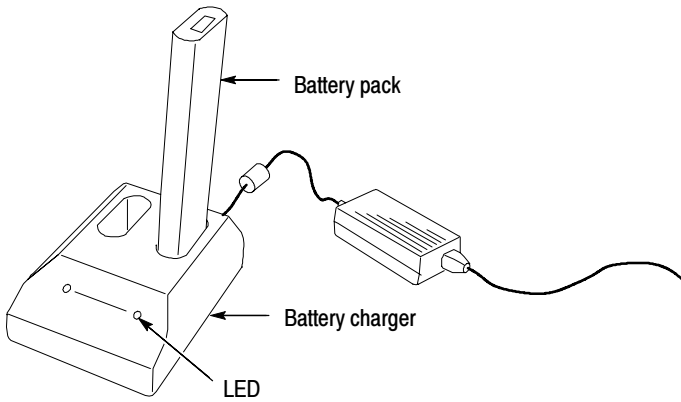

Partial Charge

Repeatedly charging partially discharged battery packs will cause them to become uncalibrated over time.

Calibrating Battery Packs

Calibration refers to the ability of a battery pack to report its current capacity, which the oscilloscope uses to calculate how much longer it can operate under the current conditions.

A battery pack loses its calibration after repeated cycles of discharging and charging in which the battery pack is not allowed to fully discharge. For example, if you operate a battery pack for one hour a day or less, and recharge it after each use, over time the battery pack will become uncalibrated.

An uncalibrated battery pack cannot accurately report its remaining operating time.

The basic idea of calibration is to cycle the battery pack from a fully charged state to a fully discharged state, and then back to a fully charged state. This is what the external charger does as part of the routine, and what the internal charge method does step-by-step.

External Calibration

You can use the optional TPSCHG battery charger (see page B-2) to calibrate battery packs. For complete information, refer to the manual for the battery charger.

To calibrate battery packs, follow these steps:

1. Place the battery pack in the left-hand slot of the charger.
2. Push the **Push to Recalibrate Left Battery Bay** button.

The charger will charge, discharge, and then fully recharge the battery pack returning it to a fully calibrated state. The calibration process can take up to ten hours to complete. Overnight calibration is recommended due to the slow nature of the discharge-charge cycle.

Internal Calibration

If you do not have a TPSCHG battery charger, you can still calibrate a battery pack inside the oscilloscope. To do so, follow these steps:

1. Power down the oscilloscope to allow a faster charge rate.
2. Apply external power from the oscilloscope AC adaptor for approximately 5 hours per battery pack.
3. Remove the oscilloscope AC adaptor.
4. Push the front panel power switch to power on the oscilloscope.
5. Operate the oscilloscope until it powers off, indicating the battery pack is fully discharged (approximately 5.5 hours for 2-channel models and 4.5 hours for 4-channel models for each battery pack).
6. Again, apply external power from the oscilloscope AC adaptor for approximately 5 hours for each battery pack. During this time, do not power on the oscilloscope.

If the battery pack is not fully charged and calibrated, attempt to calibrate the battery pack again. If the second attempt fails, replace the battery pack.

Replacing Battery Packs

Use the instructions on page 1-8 to remove and replace the battery packs.

NOTE. *Replace the Li-Ion battery packs only with the type and model recommended: TPSBAT.*

Li-Ion battery packs must be disposed of properly. See page xvi for battery pack disposal and recycling information.

To achieve optimum performance from a new battery pack, fully charge the battery pack as described on page 8-6.



Reference

Reference

This chapter describes the menus and operating details associated with each front-panel menu button or control.

Topic	Page
Acquire: menu, RUN/STOP button and SINGLE SEQ button	9-2
Application	9-6
Autorange	9-7
Autoset	9-10
Cursor	9-15
Default setup	9-16
Display	9-17
Help	9-21
Horizontal controls: menu, SET TO ZERO button, HORIZONTAL POSITION knob and SEC/DIV knob	9-21
Math	9-24
Measure	9-25
Print; Save to the CF card	9-27
Probe check	9-28
Save/Recall	9-28
Trigger controls: menu, SET TO 50% button, FORCE TRIG button, TRIG VIEW button and LEVEL knob	9-36
Utility	9-47
Vertical controls: menu, VERTICAL POSITION knobs and VOLTS/DIV knobs	9-52

Acquire

Push the ACQUIRE button to set acquisition parameters.

Options	Settings	Comments
Sample		Use to acquire and accurately display most waveforms; this is the default mode
Peak Detect		Use to detect glitches and reduce the possibility of aliasing
Average		Use to reduce random or uncorrelated noise in the signal display; the number of averages is selectable
Averages	4 16 64 128	Select number of averages

Key Points

If you probe a noisy square wave signal that contains intermittent, narrow glitches, the waveform displayed will vary depending on the acquisition mode you choose.

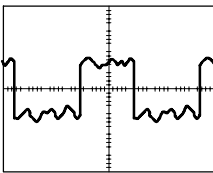

Sample

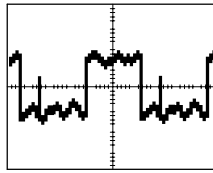

Peak Detect

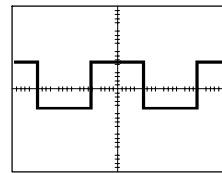

Average

Sample. Use Sample acquisition mode to acquire 2500 points and display them at the SEC/DIV setting. Sample mode is the default mode.

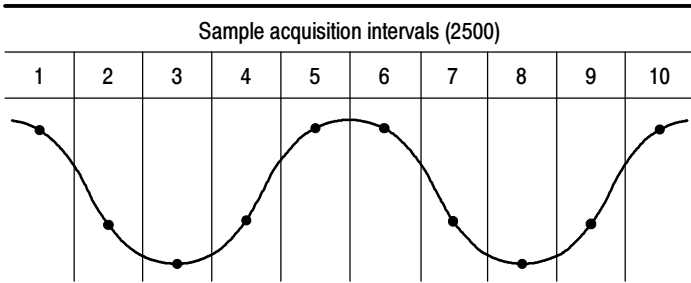

- Sample points

Sample mode acquires a single sample point in each interval.

The maximum sample rate is 1 GS/s for oscilloscope models with a bandwidth of 100 MHz and 2 GS/s for the 200 MHz models. At 100 ns and faster settings, this sample rate does not acquire 2500 points. In this case, a Digital Signal Processor interpolates points between the sampled points to make a full 2500 point waveform record.

Peak Detect. Use Peak Detect acquisition mode to detect glitches as narrow as 10 ns and to limit the possibility of aliasing. This mode is effective when at the SEC/DIV setting of 5 μ s/div or slower.

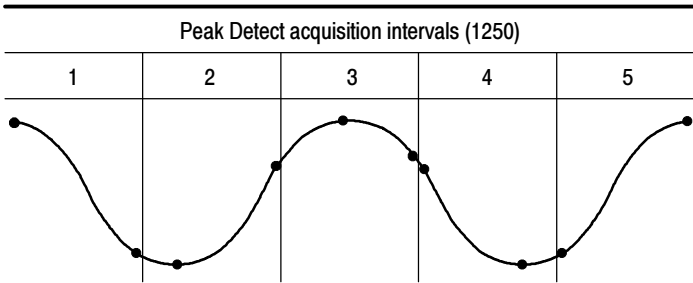

- Sample points displayed

Peak Detect mode displays the highest and lowest acquired voltage in each interval.

NOTE. *If you set the SEC/DIV setting to 2.5 μ s/div or faster, the acquisition mode changes to Sample because the sample rate is fast enough that Peak Detect is not necessary. The oscilloscope does not display a message to tell you that the mode was changed to Sample.*

When there is enough waveform noise, a typical peak detect display shows large black areas. The oscilloscope displays this area with diagonal lines to improve display performance.

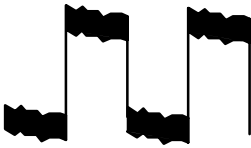

Typical peak detect display

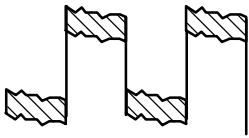

TPS2000 peak detect display

Average. Use Average acquisition mode to reduce random or uncorrelated noise in the signal you want to display. Data is acquired in sample mode, then a number of waveforms are averaged together.

Select the number of acquisitions (4, 16, 64, or 128) to average for the waveform.

RUN/STOP Button. Push the RUN/STOP button when you want the oscilloscope to continuously acquire waveforms. Push the button again to stop the acquisition.

SINGLE SEQ Button. Push the SINGLE SEQ button when you want the oscilloscope to acquire a single waveform and then stop. Each time you push the SINGLE SEQ button, the oscilloscope begins to acquire another waveform. After the oscilloscope detects a trigger it completes the acquisition and stops.

Acquisition mode	SINGLE SEQ button
Sample, Peak Detect	Sequence is complete when one acquisition is acquired
Average	Sequence is complete when the defined number of acquisitions is reached (refer to page 9-2)

Scan Mode Display. You can use the Horizontal Scan acquisition mode (also called Roll mode) to continuously monitor signals that change slowly. The oscilloscope displays waveform updates from the left to the right of the screen and erases old points as it displays new points. A moving, one-division-wide blank section of the screen separates the new waveform points from the old.

The oscilloscope changes to the Scan acquisition mode when you turn the SEC/DIV knob to 100 ms/div or slower, and select the Auto Mode option in the TRIGGER Menu.

To disable Scan mode, push the TRIG MENU button and set the Mode option to Normal.

Stopping the Acquisition. While the acquisition is running, the waveform display is live. Stopping the acquisition (when you push the RUN/STOP button) freezes the display. In either mode, the waveform display can be scaled or positioned with the vertical and horizontal controls.

Application

You can use the Application button when an Application Key is inserted in the front of the oscilloscope, such as for power analysis. For more information, refer to the user manual for the application.

Autorange

When you push the AUTORANGE button, the oscilloscope activates or deactivates the Autorange function. An LED lights adjacent to the AUTORANGE button that indicates when the function is active.

This function automatically adjusts setup values to track a signal. If the signal changes, the setup continues to track the signal. When you power on the oscilloscope, autoranging is always inactive.

Options	Comment
Autoranging	Activates or deactivates the Autorange function; when activated the adjacent LED lights
Vertical and Horizontal	Tracks and adjusts both axes
Vertical Only	Tracks and adjusts the Vertical scale; does not change the horizontal settings
Horizontal Only	Tracks and adjusts the Horizontal scale; does not change the vertical settings

The following conditions cause autorange to adjust settings:

- Too many or too few waveform periods for a clear display of the trigger source (not in Vertical Only)
- Waveform amplitude too large or too small (not in Horizontal Only)
- Ideal trigger level changes

When you push the **AUTORANGE** button, the oscilloscope adjusts controls to produce a usable display of the input signal.

Function	Setting
Acquire mode	Sample
Display format	YT
Display persist	Off
Horizontal position	Adjusted
Horizontal view	Main
RUN/STOP	RUN
SEC/DIV	Adjusted
Trigger coupling	DC
Trigger holdoff	Minimum
Trigger level	Adjusted
Trigger mode	Edge
Vertical bandwidth	Full
Vertical BW limit	Off
Vertical coupling	DC
Vertical invert	Off
VOLTS/DIV	Adjusted

The following control changes deactivate autorange:

- VOLTS/DIV deactivates vertical autoranging
- SEC/DIV deactivates horizontal autoranging
- Display or remove a channel waveform
- Trigger settings
- Single Seq acquisition mode
- Recall a setup
- XY Display format
- Persistence

The Autorange function is usually more useful than Autoset in the following situations:

- Analyzing a dynamically changing signal
- Quickly comparing a sequence of several signals without adjusting the oscilloscope. This is very useful if you need to use two probes at the same time, or you need to use a probe in one hand and are holding something else in the other.
- Controlling which settings the oscilloscope automatically adjusts

If your signals vary in frequency, but have similar amplitudes, you can use Horizontal Only autoranging. The oscilloscope will adjust the horizontal settings, but leave the vertical settings unchanged. This way, you can visually estimate the amplitude of the signal without worrying about the vertical scale changing. Vertical Only autoranging works similarly, adjusting vertical parameters and leaving the horizontal settings unchanged.

Autoset

When you push the AUTOSSET button, the oscilloscope identifies the type of waveform and adjusts controls to produce a usable display of the input signal.

Function	Setting
Acquire mode	Adjusted to Sample or Peak Detect
Cursors	Off
Display format	Set to YT
Display type	Set to Dots for a video signal, set to Vectors for an FFT spectrum; otherwise, unchanged
Horizontal position	Adjusted
SEC/DIV	Adjusted
Trigger coupling	Adjusted to DC, Noise Reject, or HF Reject
Trigger holdoff	Minimum
Trigger level	Set to 50%
Trigger mode	Auto
Trigger source	Adjusted; refer to page 9-11; cannot use Autoset on the EXT TRIG signal
Trigger slope	Adjusted
Trigger type	Edge or Video
Trigger Video Polarity	Normal
Trigger Video Sync	Adjusted
Trigger Video Standard	Adjusted
Vertical bandwidth	Full
Vertical coupling	DC (if GND was previously selected); AC for a video signal; otherwise, unchanged
VOLTS/DIV	Adjusted

The Autoset function examines all channels for signals and displays corresponding waveforms. Autoset also determines the trigger source based on the following conditions:

- If multiple channels have signals, channel with the lowest frequency signal
- No signals found, the lowest-numbered channel displayed when Autoset was invoked
- No signals found and no channels displayed, oscilloscope displays and uses channel 1



When you use Autoset and the oscilloscope cannot determine the signal type, the oscilloscope adjusts the horizontal and the vertical scales, then takes the Mean and Pk-to-Pk automatic measurements.

The Autoset function is usually more useful than Autorange in the following situations:

- Troubleshooting one stable signal
- Automatically seeing measurements of your signal
- Easily changing how the signal is presented. For example, viewing only one cycle of the waveform, or the rising edge of the waveform
- Viewing video signals or FFT signals





Sine Wave

When you use the Autoset function and the oscilloscope determines that the signal is similar to a sine wave, the oscilloscope displays the following options:

Sine wave options	Details
 Multi-cycle sine	Displays several cycles with appropriate vertical and horizontal scaling; the oscilloscope displays Cycle RMS, Frequency, Period, and Peak-to-Peak automatic measurements
 Single-cycle sine	Sets the horizontal scale to display about one cycle of the waveform; the oscilloscope displays Mean, and Peak-to-Peak automatic measurements
 FFT	Converts the input time-domain signal into its frequency components and displays the result as a graph of frequency versus magnitude (spectrum); since this is a mathematical calculation, refer to the <i>Math FFT</i> chapter on page 5-1 for more information
Undo Autoset	Causes the oscilloscope to recall the previous setup





Square Wave or Pulse

When you use the Autoset function and the oscilloscope determines that the signal is similar to a square wave or pulse, the oscilloscope displays the following options:

Square wave or pulse options	Details
 Multi-cycle square	Displays several cycles with appropriate vertical and horizontal scaling; the oscilloscope displays Pk-Pk, Mean, Period, and Frequency automatic measurements
 Single-cycle square	Sets the horizontal scale to display about one cycle of the waveform; the oscilloscope displays Min, Max, Mean, and Positive Width automatic measurements
 Rising edge	Displays the edge, and the Rise Time and Peak-to-Peak automatic measurements
 Falling edge	Displays the edge, and the Fall Time and Peak-to-Peak automatic measurements
Undo Autoset	Causes the oscilloscope to recall the previous setup

Video Signal

When you use the Autoset function and the oscilloscope determines that the signal is a video signal, the oscilloscope displays the following options:

Video signal options	Details
 Fields ▶ All Fields	Displays several fields and the oscilloscope triggers on any field
 Lines ▶ All Lines	Displays one complete line with parts of the previous and next line; the oscilloscope triggers on any line
 Lines ▶ Number	Displays one complete line with parts of the previous and next line; use the multipurpose knob to select a specific line number for the oscilloscope to use as a trigger
 Odd Fields	Displays several fields and the oscilloscope triggers only on odd fields
 Even Fields	Displays several fields and the oscilloscope triggers only on even fields
Undo Autoset	Causes the oscilloscope to recall the previous setup

NOTE. Video autoset sets the Display Type option to Dot Mode.

Cursor

Push the CURSOR button to display the measurement cursors and Cursor Menu, and then use the multipurpose knob to change the position of a cursor.

Options	Settings	Comments
Type*	Time Amplitude Off	Select and display the measurement cursors; Time measures time and frequency, and Amplitude measures amplitude, such as current or voltage
Source	CH1 CH2 CH3** CH4** MATH REFA REFB REFC** REFD**	Choose the waveform on which to take the cursor measurements Cursor readouts display the measurement
Δ		Displays the absolute value of the difference (delta) between the cursors
Cursor 1		Displays selected cursor location (time is referenced to the trigger position, and amplitude to the reference connection)
Cursor 2		

* For a Math FFT source, measures Frequency and Magnitude.

** Available only on a 4-channel oscilloscope.

Delta (Δ) values vary with the following types of cursors:

- Time cursors display Δt , $1/\Delta t$ and ΔV (or ΔI , ΔVV , and so on)
- Amplitude cursors, and Magnitude cursors (Math FFT source) display ΔV , ΔI , ΔVV , and so on
- Frequency cursors (Math FFT source) display $1/\Delta \text{Hz}$ and ΔdB

NOTE. *The oscilloscope must display a waveform for the cursors and cursor readouts to appear.*

The oscilloscope displays the time and amplitude values for each waveform when you use Time cursors.

Key Points

Cursor Movement. Use the multipurpose knob to move Cursor 1 or Cursor 2. You can move the cursors only while the Cursor Menu is displayed. The active cursor is represented by a solid line.

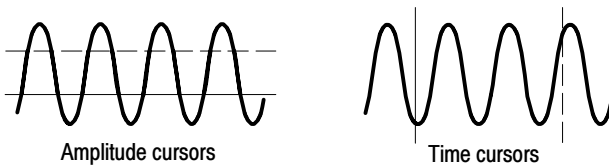

Default Setup

Push the DEFAULT SETUP button to recall most of the factory option and control settings, but not all. For more information, refer to *Appendix D: Default Setup* on page D-1.

Display

Push the DISPLAY button to choose how waveforms are presented and to change the appearance of the entire display.

Options	Settings	Comments
Type	Vectors Dots	Vectors fills the space between adjacent sample points in the display Dots displays only the sample points
Persist	OFF 1 sec 2 sec 5 sec Infinite	Sets the length of time each displayed sample point remains displayed
Format	YT XY	YT format displays the vertical voltage in relation to time (horizontal scale) XY format displays a dot each time a sample is acquired on channel 1 and channel 2 Channel 1 voltage or current determines the X coordinate of the dot (horizontal) and the channel 2 voltage or current determines the Y coordinate (vertical)
Contrast*		Makes it easier to distinguish a channel waveform from persistence
Brightness*		Contrast controls the contrast of the Liquid Crystal Display and Brightness controls the intensity of the display backlight

* **Use the multipurpose knob to adjust.**

Depending on the type, waveforms will be displayed in three different styles: solid, dimmed, and broken.

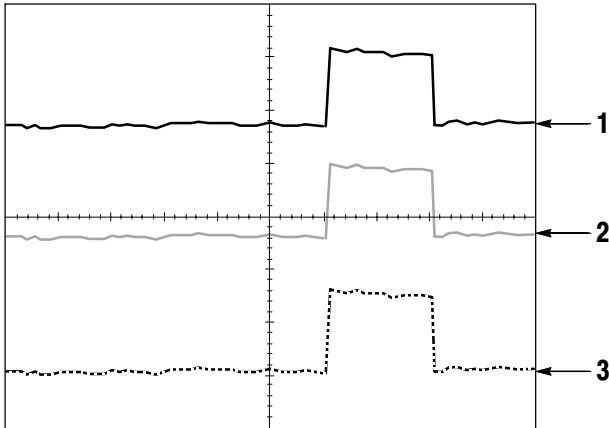

1. A solid waveform indicates a channel (live) waveform display. The waveform remains solid when the acquisition is stopped if no controls are changed that make the display accuracy uncertain.

Changing the vertical and horizontal controls is allowed on stopped acquisitions.

2. Reference waveforms appear white and waveforms with persistence applied appear in the same color as the Main waveform, but with less intensity.
3. A broken line indicates the waveform display no longer matches the controls. This happens when you stop the acquisition, and change a control setting that the oscilloscope is not able to apply to the displayed waveform. For example, changing the trigger controls on a stopped acquisition causes a broken-line waveform.

Key Points

Persistence. The oscilloscope displays persistence waveform data with less intensity than “live” waveform data. With Persistence set to Infinite, record points accumulate until a control is changed.

Option	Comments
Off	Removes default or old waveforms whenever new waveforms display
Time limit	Displays new waveforms at normal intensity and old waveforms at a lower intensity; erases old waveforms when they reach the time limit
Infinite	Older waveforms become less bright but always remain visible; use Infinite persistence to look for infrequent events and to measure long term peak-to-peak noise

XY Format. Use the XY format to analyze phase differences, such as those represented by Lissajous patterns. The format plots the voltage on channel 1 against the voltage on channel 2, where channel 1 is the horizontal axis and channel 2 is the vertical axis. The oscilloscope uses the untriggered Sample acquisition mode and displays data as dots. The sampling rate is fixed at 1 MS/s.

NOTE. *The oscilloscope can capture a waveform in normal YT mode at any sampling rate. You can view the same waveform in XY mode. To do so, stop the acquisition and change the display format to XY.*

In XY format, the controls operate as follows:

- The channel 1 VOLTS/DIV and VERTICAL POSITION controls set the horizontal scale and position.
- The channel 2 VOLTS/DIV and VERTICAL POSITION controls continue to set vertical scale and position.

The following functions do not work in XY display format:

- Autoset (resets display format to YT)
- Autorange
- Automatic measurements
- Cursors
- Reference or Math waveforms
- SAVE/RECALL ▶ Save All
- Time base controls
- Trigger controls

Help

Push the HELP button to display the Help menu. The topics cover all the menu options and controls of the oscilloscope. For more information on the Help system, refer to page xiii.

Horizontal

You can use the horizontal controls to set up two views of a waveform, each with their own horizontal scale and position. The horizontal position readout shows the time represented by the center of the screen, using the time of the trigger as zero. Changing the horizontal scale causes the waveform to expand or contract around the screen center.

Options	Comments
Main	The main horizontal time base setting is used to display the waveform
Window Zone	Two cursors define a window zone Adjust the Window Zone with the Horizontal Position and SEC/DIV controls
Window	Changes the display to show the waveform segment (expanded to screen width) within the window zone
Set Holdoff	Displays the holdoff value; push the option button and use the multipurpose knob to adjust

NOTE. You can push the horizontal option buttons to switch between an entire waveform display and a zoomed part of it.

A readout near the top right of the screen displays the current horizontal position in seconds. An **M** indicates the Main time base and a **W** indicates the Window time base. The oscilloscope also indicates horizontal position with an arrow icon at the top of the graticule.

Knobs and Buttons

HORIZONTAL POSITION Knob. Use to control the position of the trigger relative to the center of the screen.

The trigger point can be set to the left or the right of the center of the screen. The maximum number of divisions to the left depends on the Horizontal Scale (time base) setting. For most scales, the maximum is at least 100 divisions. Placing the trigger point off the screen to the left is called Delayed Sweep.

SET TO ZERO Button. Use to set the horizontal position to zero.

SEC/DIV Knob (Horizontal Scale). Use to change the horizontal time scale to magnify or compress the waveform.

Key Points

SEC/DIV. If waveform acquisition is stopped (using the RUN/STOP or SINGLE SEQ button), the SEC/DIV control expands or compresses the waveform. Use to zoom in on a detail of the waveform.

Scan Mode Display (Roll Mode). When the SEC/DIV control is set to 100 ms/div or slower and the trigger mode is set to Auto, the oscilloscope enters the Scan acquisition mode. In this mode, the waveform display updates from left to right. There is no trigger or horizontal position control of waveforms during scan mode. See page 9-6.

Window Zone. Use the Window Zone option to define a segment of a waveform to see more detail (zoom). The Window time base setting cannot be set slower than the Main time base setting.

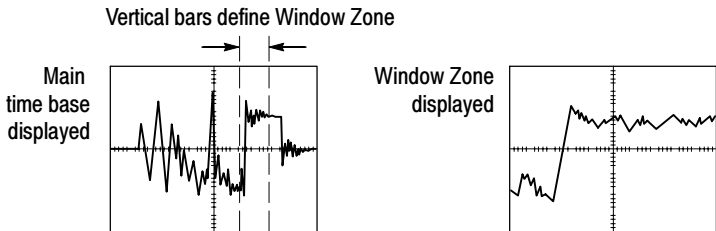

Window. Expands the Window Zone to cover the entire screen. Use to change between two time bases.

NOTE. When you change between the Main, Window Zone, and Window views, the oscilloscope erases any waveform saved on the screen through persistence.

Holdoff. Use holdoff to help stabilize the display of complex waveforms. Refer to *Holdoff* on page 9-46 for more information.

Math

Push the MATH MENU button to display waveform math operations. Push the MATH MENU button again to remove math waveforms. Refer to page 9-52 for vertical system descriptions.

Options	Comments
+ , - , × , FFT	Math operations; see the next table
Sources	Sources used for the operations; see the next table
Position	Use the multipurpose knob to set the vertical position of the resultant Math waveform
Vertical Scale	Use the multipurpose knob to set the vertical scale of the resultant Math waveform

The Math Menu includes Sources options for each operation.

Operation	Sources option	Comments
+ (addition)	CH1 + CH2	Channels 1 and 2 are added together
	CH3 + CH4*	Channels 3 and 4 are added together
- (subtraction)	CH1 - CH2	The channel 2 waveform is subtracted from the channel 1 waveform
	CH2 - CH1	The channel 1 waveform is subtracted from the channel 2 waveform
	CH3 - CH4*	The channel 4 waveform is subtracted from the channel 3 waveform
	CH4 - CH3*	The channel 3 waveform is subtracted from the channel 4 waveform
x (multiplication)	CH1 × CH2	Channels 1 and 2 are multiplied together
	CH3 × CH4*	Channels 3 and 4 are multiplied together
FFT		Refer to the <i>Math FFT</i> chapter on page 5-1

* Available only on a 4-channel oscilloscope.

Key Points

Waveform Units. The combination of source waveform units determine the resulting units for the Math waveform.

Waveform unit	Waveform unit	Operation	Resulting Math unit
V	V	+ or -	V
A	A	+ or -	A
V	A	+ or -	?
V	V	×	VV
A	A	×	AA
V	A	×	VA

Measure

Push the MEASURE button to access automatic measurements. There are eleven types of measurements available. You can display up to five at a time.

Push the top option button to display the Measure 1 Menu. You can choose the channel on which to take a measurement in the Source option. You can choose the type of measurement to take in the Type option. Push the Back option button to return to the MEASURE Menu and display the selected measurements.

Key Points

Taking Measurements. You can display up to five automatic measurements at a time for a single waveform (or divided among the waveforms). The waveform channel must be on (displayed) to make a measurement.

Automated measurements cannot be taken on reference waveforms, or while using XY or scan mode. The measurements update about two times per second.

Measurement type	Definition
Freq	Calculates the frequency of the waveform by measuring the first cycle
Period	Calculates the time of the first cycle
Mean	Calculates the arithmetic mean amplitude over the entire record
Pk-Pk	Calculates the absolute difference between the maximum and minimum peaks of the entire waveform
Cyc RMS	Calculates a true RMS measurement of the first complete cycle of the waveform
Min	Examines the entire 2500 point waveform record and displays the minimum value
Max	Examines the entire 2500 point waveform record and displays the maximum value

Measurement type	Definition
Rise Time	Measures the time between 10% and 90% of the first rising edge of the waveform.
Fall Time	Measures the time between 90% and 10% of the first falling edge of the waveform.
Pos Width	Measures the time between the first rising edge and the next falling edge at the waveform 50% level.
Neg Width	Measures the time between the first falling edge and the next rising edge at the waveform 50% level.
None	Does not take any measurement

Print

When the **SAVE/RECALL** ► **Save All** ► **PRINT** Button option is set to Prints, you can push the **PRINT** button to send the screen data to a printer or computer.

You can set up the oscilloscope to send screen data to your printer through the **UTILITY** ► **Options** ► **Printer Setup** menu, as described on page 6-3.

The alternative function of the **PRINT** button is to save data to the CompactFlash removable mass storage. See page 7-1.

Probe Check

You can use the Probe Check Wizard to quickly verify that your voltage probe is operating properly. See page 1-16.

Save/Recall

Push the SAVE/RECALL button to save oscilloscope setups, screen images, or waveforms, or to recall oscilloscope setups or waveforms.

The Save/Recall menu is made up of many submenus which you can access through an Action option. Each Action option displays a menu that allows you to further define the save or recall function.

Action options	Comments
Save All	Contains the option that configures the PRINT button to send data to a printer or to save data to the CF card
Save Image	Saves a screen image to a file in a specified format
Save Setup	Saves the current oscilloscope settings to a file in a specified folder or in nonvolatile setup memory
Save Waveform	Saves the specified waveform to a file or to reference memory
Recall Setup	Recalls an oscilloscope setup file from a CF card or from a location in nonvolatile setup memory
Recall Waveform	Recalls a waveform file from a CF card to a location in reference memory
Display Refs	Displays or removes reference memory waveforms from the screen

Save All

The Save All action configures the PRINT button to save data to a CF card, or to send data to a printer.

Options	Settings or submenus	Comments
PRINT Button	Saves All to Files*	See page 7-5 for information on file names and formats
	Saves Image to File*	See page 7-7 for information on graphic formats
	Prints	See page 6-3 for information on printer setups
Select Folder		Lists the contents of the current CF card folder
	Change Folder	See <i>File Management Conventions</i> on page 7-3 and <i>File Utilities</i> on page 9-49
	New Folder	
	Back	Returns to the Save All menu
About Save All		Displays the help topic

* An LED lights adjacent to the PRINT button to indicate the alternative SAVE function that sends data to a CF card.

Save Image

The Save Image action saves a screen image to a file in a specified format.

Options	Settings or submenus	Comments
File Format	BMP, PCX, TIFF, RLE, EPSIMAGE	Sets the screen image graphics file format
Select Folder		Lists the contents of the current CF card folder and displays the folder options
	Change Folder	See <i>File Management Conventions</i> on page 7-3 and <i>File Utilities</i> on page 9-49
	New Folder	
	Layout*	Select portrait or landscape image layout
	Ink Saver* On or Off	Activates or deactivates Ink Saver mode
Save	filename (such as TEK0000.TIF)	Saves the screen image to the automatically generated file name in the current CF card folder
About Saving Images		Displays the help topic

* See page 6-3 for information on printer setups.

When the PRINT Button option is set to Saves Image to File, the oscilloscope saves screen images to the CF card when you push the SAVE button. For more information, see page 7-7.

Save Setup

The Save Setup action saves the current oscilloscope settings to a file named TEKnnnn.SET in a specified folder, or in nonvolatile setup memory. A setup file contains an ASCII text string that lists the oscilloscope settings.

Options	Settings or submenus	Comments
Save To	Setup	Saves the current oscilloscope settings to a location in the nonvolatile setup memory
	File	Saves the current oscilloscope settings to a file on the CF card
Setup	1 to 10	Specifies which nonvolatile setup memory location to save to
Select Folder		Lists the contents of the current CF card folder
	Change Folder	See <i>File Management Conventions</i> on page 7-3 and <i>File Utilities</i> on page 9-49
	New Folder	
Save	filename (such as TEK0000.SET)	Saves the settings to the automatically generated file name in the current CF card folder

When the PRINT Button option is set to Saves All to Files, the oscilloscope saves oscilloscope setup files to the CF card when you push the SAVE button. For more information, see page 7-5.

Save Waveform

The Save Waveform action saves the specified waveform to a file named TEKnnnn.CSV, or to reference memory. The oscilloscope saves waveform data to files as “comma separated values” (.CSV format), which are ASCII text strings that list the time (relative to the trigger) and amplitude values for each of the 2500 waveform data points. You can import .CSV files into many spreadsheet and math analysis applications.

Options	Settings or submenus	Comments
Save To	Ref	Specifies to save the source waveform data to a file on the CF card
	File	Specifies to save the source waveform data in reference memory
Source*	CH(x), Ref(x), MATH	Specifies which source waveform to save
To	Ref(x)	Specifies the reference memory location in which to save the source waveform
Select Folder		Lists the contents of the current CF card folder
	Change Folder	See <i>File Management Conventions</i> on page 7-3 and <i>File Utilities</i> on page 9-49
	New Folder	
Save	filename (such as TEK0000.CSV)	Saves the settings to the automatically generated file name in the current CF card folder

* **Waveform must be displayed to save it as a reference waveform.**

Recall Setup

The Recall Setup action recalls an oscilloscope setup file from a CF card or from a location in nonvolatile setup memory.

Options	Settings or submenus	Comments
Recall From	Setup	Specifies to recall a setup from the nonvolatile memory
	File	Specifies to recall a setup file from the CF card
Setup	1 to 10	Specifies which setup location in nonvolatile setup memory to recall
Select Folder		Lists the contents of the current CF card folder to select a file from
	Change Folder	See <i>File Management Conventions</i> on page 7-3 and <i>File Utilities</i> on page 9-49
Recall		Recalls the settings from the specified nonvolatile memory location
	filename (such as TEK0000.SET)	Recalls the oscilloscope settings from the specified CF card file

Recall Waveform

The Recall Waveform action recalls a waveform file from a CF card to a location in reference memory.

Options	Settings or submenus	Comments
To	Ref(x)	Specifies the reference memory location to load the waveform to
Select File		Lists the contents of the current CF card folder and displays the next folder option
	Change Folder	See <i>File Management Conventions</i> on page 7-3 and <i>File Utilities</i> on page 9-49
	To	Specifies the reference memory location to recall the waveform to
Recall	filename (such as TEK0000.CSV)	Loads the waveform from the specified file to the location in reference memory and displays the waveform

Display Refs

The Display Refs action displays or removes reference memory waveforms from the screen of the oscilloscope.

Options	Settings	Comments
RefA	On, Off	Displays or removes reference memory waveforms from the screen
RefB		
RefC*		
RefD*		

* Available only on a 4-channel oscilloscope.

Key Points

Saving and Recalling Setups. The complete setup is stored in nonvolatile memory. When you recall the setup, the oscilloscope will be in the mode from which the setup was saved.

The oscilloscope saves the current setup if you wait three seconds after the last change before you power off the oscilloscope. The oscilloscope then recalls this setup the next time you apply power.

Recalling the Default Setup. You can push the DEFAULT SETUP button to initialize the oscilloscope to a known setup. To view option and control settings that the oscilloscope recalls when you push this button, refer to *Appendix D: Default Setup* on page D-1.

Saving and Recalling Waveforms. The oscilloscope must display any waveform that you want to save. Two-channel oscilloscopes can store two reference waveforms in internal nonvolatile memory. Four-channel oscilloscopes can store four, but only display two at a time.

The oscilloscope can display both reference waveforms and channel waveform acquisitions. Reference waveforms are not adjustable, but the oscilloscope does display the horizontal and vertical scales at the bottom of the screen.

Trigger Controls

You can define the trigger through the Trigger Menu and front-panel controls.

Trigger Types

Three types of triggering are available: Edge, Video, and Pulse Width. A different set of options display for each type of trigger.

Option	Details
Edge (default)	Triggers the oscilloscope on the rising or falling edge of the input signal when it crosses the trigger level (threshold)
Video	Displays NTSC or PAL/SECAM standard composite video waveforms; you trigger on fields or lines of video signals. Refer to <i>Video</i> on page 9-41
Pulse	Triggers on aberrant pulses. Refer to <i>Pulse Width Trigger</i> on page 9-42

Edge Trigger

Use Edge triggering to trigger on the edge of the oscilloscope input signal at the trigger threshold.

Options	Settings	Comments
Edge		With Edge highlighted, the rising or falling edge of the input signal is used for the trigger
Source	CH1 CH2 CH3* CH4* Ext Ext/5 Ext/10	Select the input source as the trigger signal; see page 9-39
Slope	Rising Falling	Select to trigger on either the rising or falling edge of the signal
Mode	Auto Normal	Select the type of triggering; see page 9-38
Coupling	AC DC Noise Reject HF Reject LF Reject	Selects the components of the trigger signal applied to the trigger circuitry; see page 9-40

* Available only on a 4-channel oscilloscope.

Trigger Frequency Readout

The oscilloscope counts the rate at which triggerable events occur to determine trigger frequency and displays the frequency in the lower right corner of the screen.

NOTE. *The trigger frequency readout shows the frequency of events the oscilloscope might consider to be a trigger, and may be less than the frequency of the input signal in Pulse Width trigger mode.*

Key Points

Mode Options.

Mode option	Details
Auto (default)	<p>Forces the oscilloscope to trigger when it does not detect a trigger within a certain amount of time based on the SEC/DIV setting; you can use this mode in many situations, such as to monitor the level of a power supply output</p> <p>Use this mode to let the acquisition free-run in the absence of a valid trigger; this mode allows an untriggered, scanning waveform at 100 ms/div or slower time base settings</p>
Normal	<p>Updates displayed waveforms only when the oscilloscope detects a valid trigger condition; the oscilloscope displays older waveforms until the oscilloscope replaces them with new ones</p> <p>Use this mode when you want to see only valid triggered waveforms; when you use this mode, the oscilloscope does not display a waveform until after the first trigger</p>

To perform a Single Sequence acquisition, push the SINGLE SEQ button.

Source Options.

Source option	Details
Numbered channels	Triggers on a channel whether or not the waveform is displayed
Ext	Does not display the trigger signal; the Ext option uses the signal connected to the EXT TRIG front-panel BNC and allows a trigger level range of +4 V to -4 V
Ext/5	Same as Ext option, but attenuates the signal by a factor of five, and allows a trigger level range of +20 V to -20 V; this extends the trigger level range
Ext/10	Same as Ext option, but attenuates the signal by a factor of ten, and allows a trigger level range of +40 V to -40 V; this extends the trigger level range

NOTE. To view an Ext, Ext/5, or Ext/10 trigger signal, push and hold down the TRIG VIEW button.

Coupling. Coupling allows you to filter the trigger signal used to trigger an acquisition.

Option	Details
DC	Passes all components of the signal
Noise Reject	Adds hysteresis to the trigger circuitry; this reduces sensitivity which reduces the chance of falsely triggering on noise
HF Reject	Attenuates the high-frequency components above 80 kHz
LF Reject	Blocks the DC component and attenuates the low-frequency components below 300 kHz
AC	Blocks DC components and attenuates signals below 10 Hz

NOTE. *Trigger coupling affects only the signal passed to the trigger system. It does not affect the bandwidth or coupling of the signal displayed on the screen.*

Pretrigger. The trigger position is typically set at the horizontal center of the screen. In this case, you are able to view five divisions of pretrigger information. Adjusting the Horizontal Position of the waveform allows you to see more or less pretrigger information.

Video Trigger

Options	Settings	Comments
Video		With Video highlighted, triggering occurs on an NTSC, PAL, or SECAM standard video signal Trigger coupling is preset to AC
Source	CH1 CH2 CH3* CH4* Ext Ext/5 Ext/10	Selects the input source as the trigger signal Ext, Ext/5, and Ext/10 use the signal applied to the EXT TRIG connector
Polarity	Normal Inverted	Normal triggers on the negative edge of the sync pulse and Inverted triggers on the positive edge of the sync pulse
Sync	All Lines Line Number Odd Field Even Field All Fields	Select appropriate video sync Use the multipurpose knob to specify a line number when you select Line Number for the Sync option
Standard	NTSC PAL/SECAM	Select the video standard for sync and line number count

* Available only on a 4-channel oscilloscope.

Key Points

Sync Pulses. When you choose Normal Polarity, the trigger always occurs on negative-going sync pulses. If your video signal has positive-going sync pulses, use the Inverted Polarity selection.

Pulse Width Trigger

Use Pulse Width triggering to trigger on aberrant pulses.

Options	Settings	Comments
Pulse		With Pulse highlighted, triggering occurs on pulses that meet the trigger condition defined by the Source, When, and Set Pulse Width options
Source	CH1 CH2 CH3* CH4* Ext Ext/5 Ext/10	Select the input source as the trigger signal
When	= ≠ < >	Select how to compare the trigger pulse relative to the value selected in the Pulse Width option
Pulse Width	33 ns to 10.0 sec	Use the multipurpose knob to set a width
Polarity	Positive Negative	Select to trigger on positive or negative pulses

Options	Settings	Comments
Mode	Auto Normal	Select the type of triggering; Normal mode is best for most Pulse Width trigger applications
Coupling	AC DC Noise Reject HF Reject LF Reject	Selects the components of the trigger signal applied to the trigger circuitry; see <i>Edge Trigger</i> for details on page 9-37
More		Use to switch between submenu pages

* Available only on a 4-channel oscilloscope.

Trigger Frequency Readout

The oscilloscope counts the rate at which trigger events occur to determine trigger frequency and displays the frequency in the lower right corner of the screen.

Key Points

Trigger When. The pulse width of the source must be ≥ 5 ns for the oscilloscope to detect the pulse.

When options	Details
= ≠	Triggers the oscilloscope when the signal pulse width is equal to or not equal to the specified pulse width within a $\pm 5\%$ tolerance
< >	Triggers the oscilloscope when the source signal pulse width is less than or greater than the specified pulse width

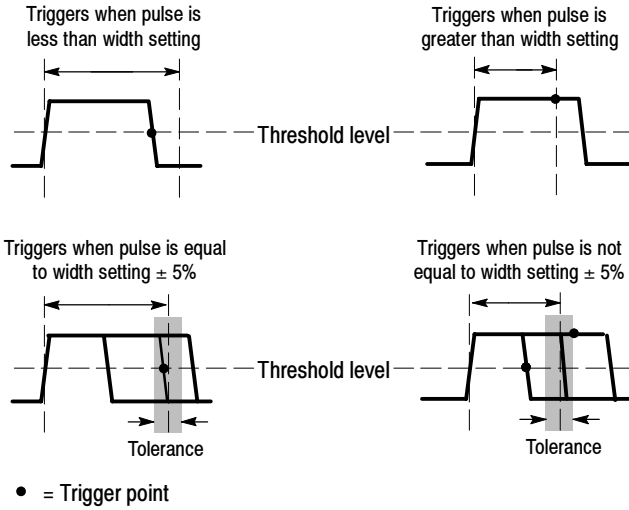

Refer to page 4-25 for an example of triggering on aberrant pulses.

Knobs and Buttons

LEVEL Knob. Use to control the Trigger Level.

SET TO 50% Button. Use the SET TO 50% button to quickly stabilize a waveform. The oscilloscope automatically sets the Trigger Level to be about halfway between the minimum and maximum voltage levels. This is useful when you connect a signal to the EXT TRIG BNC and set the trigger source to Ext, Ext/5, or Ext/10.

FORCE TRIG Button. Use the FORCE TRIG button to complete the current waveform acquisition whether or not the oscilloscope detects a trigger. This is useful for SINGLE SEQ acquisitions and Normal trigger mode. (In Auto trigger mode, the oscilloscope automatically forces triggers periodically if it does not detect a trigger.)

TRIG VIEW Button. Use the Trigger View mode to have the oscilloscope display the conditioned trigger signal. You can use this mode to see the following types of information: effects of the Trigger Coupling option and the signal connected to the EXT TRIG BNC.

NOTE. *This is the only button that you must hold down to use. When you hold down the TRIG VIEW button, the only other button you can use is the PRINT button. The oscilloscope disables all other front-panel buttons. The knobs continue to be active.*

Holdoff. You can use the Trigger Holdoff function to produce a stable display of complex waveforms, such as pulse trains. Holdoff is the time between when the oscilloscope detects one trigger and when it is ready to detect another. The oscilloscope will not trigger during the holdoff time. For a pulse train, you can adjust the holdoff time so the oscilloscope triggers only on the first pulse in the train.

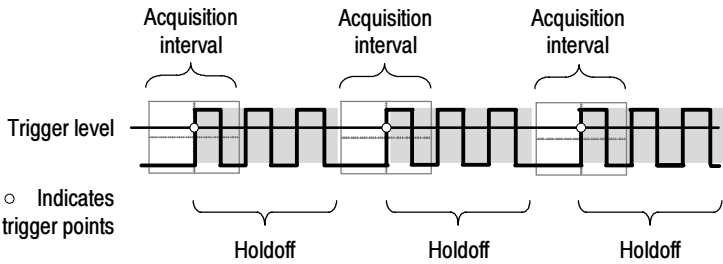

Triggers are not recognized during holdoff time.

To use Trigger Holdoff, push the **HORIZ MENU ▶ Set Holdoff** option button and use the multipurpose knob to adjust the holdoff. The resolution of the trigger holdoff varies depending on the Horizontal SEC/DIV setting.

Utility

Push the UTILITY button to display the Utility Menu.

Options	Settings	Comments
System Status		Displays summaries of the oscilloscope settings
Options	Front Panel Backlight	Enables Illumination of the front panel
	Printer Setup	Displays the setup for the printer; see page 6-2
	RS232 Setup	Displays the setup for the RS-232 port; see page 6-5
	Set Date and Time	Displays the setup for the date and time; see page 9-48
	Error Log	Displays a list of any errors logged and the Power Cycle count This list is useful when contacting a Tektronix Service Center for help
Do Self Cal		Performs a self calibration
File Utilities		Displays folder, file, and CF card options; see page 9-49
Language	English French German Italian Spanish Portuguese Japanese Korean Simplified Chinese Traditional Chinese	Selects the display language of the oscilloscope

Key Points

System Status. Selecting System Status from the Utility Menu displays the menus available for obtaining a list of control settings for each group of oscilloscope controls.

Push any front-panel menu button to remove the status screen.

Options	Comments
Horizontal	Lists horizontal parameters of channels
Vertical	Lists vertical parameters of channels
Trigger	Lists trigger parameters
Misc	Lists the model of the oscilloscope and the software version number Lists the charge status of the battery packs Lists values of the communications parameters

Setting the Date and Time. You can use the Set Date and Time menu to set the clock date and time. The oscilloscope displays this information, and also uses it to time stamp files written to the CF card. The oscilloscope contains a built-in nonreplaceable battery to maintain the clock settings.

The clock does not automatically adjust for seasonal time changes. The calendar does adjust for Leap years.

Options	Comments
↑ ↓	Moves the field selection highlight up or down through the list. Use the multipurpose knob to change the value of the selected field
Set Date and Time	Updates the oscilloscope with the specified date and time
Cancel	Closes the menu and returns to the previous menu without saving any changes

Self Calibration. The self calibration routine optimizes the oscilloscope accuracy for the ambient temperature. For maximum accuracy, perform a self cal if the ambient temperature changes by 5 °C (9 °F) or more. For accurate calibration, power on the oscilloscope and wait twenty minutes to ensure it is warmed up. Follow the directions on the screen.

Factory calibration uses externally-generated voltages, and requires specialized equipment. The recommended interval is one year. See Contacting Tektronix on page xvii for information on having Tektronix perform a Factory Calibration of your oscilloscope.

File Utilities

You can use the File Utilities menu to do the following tasks:

- List the contents of the current CF card folder
- Select a file or folder
- Navigate to other folders
- Create, rename, and delete files and folders
- Format the CF card

Options	Comments
Change Folder	Navigates to the selected CF card folder. Use the multipurpose knob to select a file or folder, then select the Change Folder menu option to navigate to the selected folder
	To return to the previous folder, select the ↑ Up folder item and then select the Change Folder menu option
New Folder	Creates a new folder in the current folder location, named NEW_FOL, and displays the Rename menu for changing the default folder name
Delete (filename or folder)	Deletes the selected file name or folder. A folder must be empty before you can delete it
Confirm Delete	Displays after pressing Delete, to confirm a file delete action. Pressing any button or knob other than Confirm Delete cancels the file delete action
Format	Formats the CF card; this deletes all data on the CF card
Update Firmware	Follow the on-screen directions to set up and push the Update Firmware option button to start updating firmware
Rename (filename or folder)	Displays the Rename screen to rename a folder or file; see page 9-51

Rename File or Folder. You can change the names of files and folders on the CF card.

Option	Settings or submenus	Comments
Enter Character	A - Z 0 - 9 - .	Enters the highlighted alphanumeric character at the current Name field cursor position
		Use the multipurpose knob to select an alphanumeric character or the Backspace, Delete Character, or Clear Name functions
	Backspace	Changes the menu button 1 option to the Backspace function. Deletes the character to the left of the highlighted character in the Name field
	Delete Character	Changes the menu button 1 option to the Delete Character function. Deletes the highlighted character from the Name field
	Clear Name	Changes the menu button 1 option to Clear Name. Deletes all characters from the Name field

Vertical

You can use the vertical controls to display and remove waveforms, adjust vertical scale and position, and set input parameters. See page 9-24 for the vertical math descriptions.

Channel Vertical Menus

There is a separate vertical menu for each channel. Each option is set individually for each channel.

Options	Settings	Comments
Coupling	DC	DC passes both AC and DC components of the input signal
	AC	AC blocks the DC component of the input signal and attenuates signals below 10 Hz
	GND	GND disconnects the input signal
BW Limit	20 MHz* Off	Limits the bandwidth to reduce display noise; filters the signal to reduce noise and other unwanted high frequency components
Volts/Div	Coarse Fine	Selects the resolution of the Volts/Div knob Coarse defines a 1-2-5 sequence. Fine changes the resolution to small steps between the coarse settings
Probe	See next table	Push to adjust Probe options
Invert	On Off	Inverts (flips) the waveform with respect to the reference level

* Effective bandwidth is 6 MHz with a P2220 probe set to 1X.

The option for voltage and current probes is different: Attenuation or Scale.

Probe options	Settings	Comments
Voltage ▶ Attenuation	1X 10X 20X 50X 100X 500X 1000X	Set to match the attenuation factor of the voltage probe to ensure correct vertical readouts
Current ▶ Scale	5 V/A 1 V/A 200 mV/A 100 mV/A 50 mV/A 20 mV/A 10 mV/A 1 mV/A	Set to match the scale of the current probe to ensure correct vertical readouts
Back		Returns to the previous menu

Knobs

VERTICAL POSITION Knobs. Use the VERTICAL POSITION knobs to move the channel waveforms up or down on the screen.

VOLTS/DIV Knobs. Use the VOLTS/DIV knobs to control how the oscilloscope amplifies or attenuates the source signal of channel waveforms. When you turn a VOLTS/DIV knob, the oscilloscope increases or decreases the vertical size of the waveform on the screen.

Vertical Measurement Overrange (Clipping). Waveforms that extend beyond the screen (overrange) and display a "???" in the measurement readout indicates an invalid value. Adjust the vertical scaling to ensure the readout is valid.

Key Points

GND Coupling. Use GND coupling to display a zero-volt waveform. Internally, the channel input is connected to a zero-volt reference level.

Fine Resolution. The vertical scale readout displays the actual Volts/Div setting while in the fine resolution setting. Changing the setting to coarse does not change the vertical scale until the VOLTS/DIV control is adjusted.

Remove Waveform. To remove a waveform from the display, push the menu button for the channel to display its vertical menu. Push the menu button again to remove the waveform.

NOTE. *You do not have to display a channel waveform to use it as a trigger source or for math operations.*

You must display a channel waveform to take measurements from it, use cursors on it, or to save it as a Reference waveform or to a file.



Appendices

Appendix A: Specifications

All specifications apply to the TPS2000 series oscilloscopes. P2220 probe specifications appear at the end of this chapter. To verify that the oscilloscope meets specifications, the oscilloscope must first meet the following conditions:

- The oscilloscope must have been operating continuously for twenty minutes within the specified operating temperature.
- You must perform the Do Self Cal operation, accessible through the Utility menu, if the operating temperature changes by more than 5 °C (9 °F).
- The oscilloscope must be within the factory calibration interval

All specifications are guaranteed unless noted “typical.”

Oscilloscope Specifications

Acquisition		
Acquisition Modes	Sample, Peak Detect, and Average	
Acquisition Rate, typical	Up to 180 waveforms per second, per channel (Sample acquisition mode, no measurements)	
Single Sequence	<i>Acquisition Mode</i>	<i>Acquisition Stops After</i>
	Sample, Peak Detect	Single acquisition, all channels simultaneously
	Average	N acquisitions, all channels simultaneously, N is selectable from 4, 16, 64, and 128

Oscilloscope Specifications (Cont.)

Inputs		
Input Coupling	DC, AC, or GND	
Input Impedance, DC Coupled	1 M Ω \pm 2% in parallel with 20 pF \pm 3 pF	
P2220 Probe Attenuation	1X, 10X	
Supported Voltage Probe Attenuation Factors	1X, 10X, 20X, 50X, 100X, 500X, 1000X	
Supported Current Probe Scales	5 V/A, 1 V/A, 200 mV/A, 100 mV/A, 50 mV/A, 20 mV/A, 10 mV/A, 1 mV/A	
Maximum Voltage Between Signal and Reference at input BNC	<i>Overvoltage Category</i>	<i>Maximum Voltage</i>
	CAT II	300 V _{RMS}
	CAT III	150 V _{RMS}
	Derate at 20 dB/decade above 100 kHz to 13 V peak AC at 3 MHz and above. For non-sinusoidal waveforms, peak value must be less than 450 V. Excursion above 300 V should be less than 100 ms duration. RMS signal level including any DC component removed through AC coupling must be limited to 300 V. If these values are exceeded, damage to the instrument may result. Refer to the Overvoltage Category description on page A-15.	
Maximum Voltage Between BNC Reference and Earth Ground	600 V _{RMS} CAT II or 300 V _{RMS} CAT III, using rated connectors or accessories	

Oscilloscope Specifications (Cont.)

Inputs		
Channel Common Mode Rejection, typical	Greater than 1000:1, up to 50 MHz, derated to 400:1 at 200 MHz, sinewave, with Volts/Div setting at 5 mV	
	With the signal applied between the channel (signal and signal reference) to chassis, the ratio of the acquired signal amplitude to the amplitude of the signal	
Channel-to-Channel Crosstalk	TPS2012 and TPS2014	TPS2024
	≥ 100:1 at 50 MHz	≥ 100:1 at 100 MHz
	Measured on one channel, with test signal applied between signal and reference of the other channel, and with the same VOLTS/DIV and coupling settings on each channel	
Vertical		
Digitizers	8-bit resolution (except when set to 2 mV/div), each channel sampled simultaneously	
VOLTS/DIV Range	2 mV/div to 5 V/div at input BNC	
Position Range	2 mV/div to 200 mV/div, ±2 V > 200 mV/div to 5 V/div, ±50 V	

Oscilloscope Specifications (Cont.)

Vertical

Analog Bandwidth in Sample and Average modes at BNC or with P2220 probe set to 10X, DC Coupled	TPS2012 and TPS2014	TPS2024
	100 MHz†	200 MHz† (5 mV/div bandwidth is 200 MHz, typical) (at 40 °C to 50 °C ambient, bandwidth is 200 MHz, typical)
	20 MHz (when vertical scale is set to < 5 mV)	
Analog Bandwidth in Peak Detect mode (50 s/div to 5 μs/div*), typical	75 MHz†	
	20 MHz (when vertical scale is set to < 5 mV)	
Selectable Analog Bandwidth Limit, typical	20 MHz	
Lower Frequency Limit, AC Coupled	≤ 10 Hz at BNC ≤ 1 Hz when using a 10X passive probe	
Rise Time at BNC, typical	TPS2012 and TPS2014	TPS2024
	< 3.5 ns	< 2.1 ns

† When vertical scale is set to > 5 mV.

* The oscilloscope reverts to Sample mode when the SEC/DIV (horizontal scale) is set from 2.5 μs/div to 5 ns/div on 100 MHz models, or from 2.5 μs/div to 2.5 ns/div on a TPS2024 model. Sample mode can capture 12 ns glitches.

Oscilloscope Specifications (Cont.)

Vertical		
Peak Detect Response*	Captures 50% or greater amplitude of pulses ≥ 12 ns wide typical (50 s/div to 5 μ s/div) in the center 8 vertical divisions	
DC Gain Accuracy	$\pm 3\%$ for Sample or Average acquisition mode, 5 V/div to 10 mV/div	
	$\pm 4\%$ for Sample or Average acquisition mode, 5 mV/div and 2 mV/div	
DC Measurement Accuracy, Average Acquisition Mode	<i>Measurement Type</i>	<i>Accuracy</i>
	Average of ≥ 16 waveforms with vertical position at zero	$\pm(3\% \times \text{reading} + 0.1 \text{ div} + 1 \text{ mV})$ when 10 mV/div or greater is selected
	Average of ≥ 16 waveforms with vertical position <u>not</u> at zero	$\pm[3\% \times (\text{reading} + \text{vertical position}) + 1\% \text{ of vertical position} + 0.2 \text{ div}]$ Add 2 mV for settings from 2 mV/div to 200 mV/div Add 50 mV for settings from > 200 mV/div to 5 V/div
Volts Measurement Repeatability, Average Acquisition Mode	Delta volts between any two averages of ≥ 16 waveforms acquired under same setup and ambient conditions	$\pm(3\% \times \text{reading} + 0.05 \text{ div})$

* The oscilloscope reverts to Sample mode when the SEC/DIV (horizontal scale) is set from 2.5 μ s/div to 5 ns/div on 100 MHz models, or from 2.5 μ s/div to 2.5 ns/div on a TPS2024 model. Sample mode can capture 12 ns glitches.

Oscilloscope Specifications (Cont.)

Horizontal		
Sample Rate Range	TPS2012 and TPS2014	TPS2024
	5 S/s to 1 GS/s	5 S/s to 2 GS/s
Waveform Interpolation	(sin x)/x	
Record Length	2500 samples for each channel	
SEC/DIV Range	TPS2012 and TPS2014	TPS2024
	5 ns/div to 50 s/div, in a 1, 2.5, 5 sequence	2.5 ns/div to 50 s/div, in a 1, 2.5, 5 sequence
Sample Rate and Delay Time Accuracy	±50 ppm over any ≥1 ms time interval	
Delta Time Measurement Accuracy (Full Bandwidth)	<i>Conditions</i>	<i>Accuracy</i>
	Single-shot, Sample mode	±(1 sample interval + 100 ppm × reading + 0.6 ns)
	> 16 averages	±(1 sample interval + 100 ppm × reading + 0.4 ns)
	Sample interval = s/div ÷ 250	
Position Range	2.5 ns/div to 10 ns/div	(-4 div × s/div) to 20 ms
	25 ns/div to 100 μs/div	(-4 div × s/div) to 50 ms
	250 μs/div to 10 s/div	(-4 div × s/div) to 50 s
	25 s/div to 50 s/div	(-4 div × s/div) to 250 s

Oscilloscope Specifications (Cont.)

Trigger			
Trigger Sensitivity, Edge Trigger Type	<i>Coupling</i>	<i>Sensitivity</i>	
	DC	CH1, CH2, CH3*, CH4*	1 div from DC to 10 MHz, 1.5 div from 10 MHz to Full
		EXT	1 V from 50 Hz to Full
		EXT/5	5 V from 50 Hz to Full
		EXT/10	10 V from 50 Hz to Full
Trigger Sensitivity, Edge Trigger Type, typical	<i>Coupling</i>	<i>Sensitivity</i>	
	AC	Same as DC-coupled limits from 50 Hz and above	
	NOISE REJ	Reduces the DC-coupled trigger sensitivity by 2 times for > 10 mv/div to 5 V/div	
	HF REJ	Same as the DC-coupled limit from DC to 7 kHz, attenuates signals above 80 kHz	
	LF REJ	Same as the DC-coupled limits for frequencies above 300 kHz, attenuates signals below 300 kHz	
Trigger Level Range	<i>Source</i>	<i>Range</i>	
	CH1, CH2, CH3*, CH4*	±8 divisions from center of screen	
	EXT	±4 V	
	EXT/5	±20 V	
	EXT/10	±35 V	

* Available only on a 4-channel oscilloscope.

Oscilloscope Specifications (Cont.)

Trigger		
Trigger Level Accuracy, typical	Accuracies are for signals having rise and fall times ≥ 20 ns	
	<i>Source</i> <i>Accuracy</i>	
	Internal	$\pm 0.2 \text{ div} \times \text{volts/div}$ within ± 4 divisions from center screen
	EXT	$\pm (6\% \text{ of setting} + 250 \text{ mV})$ for signals $< \pm 2 \text{ V}$
	EXT/5	$\pm (6\% \text{ of setting} + 500 \text{ mV})$ for signals $< \pm 10 \text{ V}$
	EXT/10	$\pm (6\% \text{ of setting} + 1 \text{ V})$ for signals $< \pm 20 \text{ V}$
SET LEVEL TO 50%, typical	Operates with input signals $\geq 50 \text{ Hz}$	
Default Settings, Video Trigger	Coupling is AC and Auto mode except for a single sequence acquisition	
Sensitivity, Video Trigger Type, typical	Composite video signal	
	<i>Source</i> <i>Range</i>	
	Internal	Pk-pk amplitude of 2 divisions
	EXT	$\pm 1 \text{ V}$
	EXT/5	$\pm 5 \text{ V}$
	EXT/10	$\pm 10 \text{ V}$
Signal Formats and Field Rates, Video Trigger Type	Supports NTSC, PAL, and SECAM broadcast systems for any field or any line	
Holdoff Range	500 ns to 10 s	

Oscilloscope Specifications (Cont.)

Pulse Width Trigger	
Pulse Width Trigger modes	Trigger when < (Less than), > (Greater than), = (Equal), or \neq (Not Equal); Positive pulse or Negative pulse
Pulse Width Trigger Point	<p>Equal: The oscilloscope triggers when the trailing edge of the pulse crosses the trigger level.</p> <p>Not Equal: If the pulse is narrower than the specified width, the trigger point is the trailing edge. Otherwise, the oscilloscope triggers when a pulse continues longer than the time specified as the Pulse Width.</p> <p>Less than: The trigger point is the trailing edge.</p> <p>Greater than (also called time-out trigger): The oscilloscope triggers when a pulse continues longer than the time specified as the Pulse Width.</p>
Pulse Width Range	Selectable from 33 ns to 10 s
Pulse Width Resolution	16.5 ns or 1 part per thousand, whichever is larger
Equal Guardband	$t > 330 \text{ ns}: \pm 5\% \leq \text{guardband} < \pm(5.1\% + 16.5 \text{ ns})$ $t \leq 330 \text{ ns}: \text{guardband} = \pm 16.5 \text{ ns}$
Not Equal Guardband	$t > 330 \text{ ns}: \pm 5\% \leq \text{guardband} < \pm(5.1\% + 16.5 \text{ ns})$ $165 \text{ ns} < t \leq 330 \text{ ns}: \text{guardband} = -16.5 \text{ ns}/+33 \text{ ns}$ $t \leq 165 \text{ ns}: \text{guardband} = \pm 16.5 \text{ ns}$

Oscilloscope Specifications (Cont.)

Trigger Frequency Counter	
Readout Resolution	6 digits
Accuracy (typical)	±51 parts per million including all frequency reference errors and ±1 count errors
Frequency Range	AC coupled, 10 Hz minimum to rated bandwidth
Signal Source	<p>Pulse Width or Edge Trigger modes: all available trigger sources</p> <p>The Frequency Counter measures trigger source at all times in Pulse Width or Edge modes, including when the oscilloscope acquisition is halted due to changes in the run status, or acquisition of a single shot event has completed.</p> <p>Pulse Width Trigger mode: The oscilloscope counts pulses of significant magnitude inside the 250 ms measurement window that qualify as triggerable events, such as narrow pulses in a PWM pulse train if set to < mode and the width is set to a relatively small time.</p> <p>Edge Trigger mode: The oscilloscope counts all edges of sufficient magnitude and correct polarity.</p> <p>Video Trigger mode: The Frequency Counter does not operate.</p>

Oscilloscope Specifications (Cont.)

Measurements	
Cursors	Amplitude difference between cursors (ΔV , ΔA , or ΔVA) Time difference between cursors (Δt) Reciprocal of Δt in Hertz ($1/\Delta t$)
Automatic Measurements	Frequency, Period, Mean, Pk-Pk, Cycle RMS, Min, Max, Rise Time, Fall Time, Pos Width, Neg Width

Oscilloscope General Specifications

Display	
Display Type	5.7 in. (145 mm) diagonal liquid crystal
Display Resolution	320 horizontal by 240 vertical pixels
Display Brightness	Adjustable
Display Contrast	Adjustable, temperature compensated
Backlight Intensity, typical*	60 to 100 cd/m ²
Probe Compensator Output	
Output Voltage, typical	5 V \pm 10% into $\geq 1 \text{ M}\Omega$ load
Frequency, typical	1 kHz
Power Source	
Source Voltage of the Oscilloscope AC Adaptor	90 to 264 VAC _{RMS} from 45 Hz through 66 Hz
Power Consumption	Less than 30 W

* **Adjustable through the Display menu.**

Oscilloscope General Specifications (Cont.)

Environmental		
Pollution Degree	Pollution Degree 2 ¹ . Do not operate in an environment where conductive pollutants may be present.	
Enclosure Rating	IP 30 ² - When the CompactFlash card and optional Application key are installed, the rating becomes IP40 ² .	
Temperature	Operating	32 °F to 122 °F (0 °C to +50 °C)
	Nonoperating	-40 °F to 159.8 °F (-40 °C to +71 °C) See also: <i>Battery Charging Temperature and Discharging Temperature</i> on page 8-2.
Cooling Method	Forced air, temperature controlled	
Humidity	Operating	High: 50 °C (122 °F)/60% RH Low: 30 °C (86°F)/60% RH
	Non-operating	High: 55 °C to 71 °C (131 °F to 160°F), 60% RH max wet bulb Low: 0 °C to 30 °C (32 °F to 86°F), ≤ 90% RH max wet bulb
Altitude	Operating and Nonoperating	3,000 m (10,000 ft)
Random Vibration with one battery pack	Operating	0.31 g _{RMS} from 5 Hz to 500 Hz, 10 minutes on each of 3 axis
	Nonoperating	2.46 g _{RMS} from 5 Hz to 500 Hz, 10 minutes on each of 3 axis
Mechanical Shock with one battery pack	Operating	50 g, 11 ms, half sine

Oscilloscope General Specifications (Cont.)

Mechanical		
Size, without front protection cover	Height	160.8 mm (6.33 in.)
	Width	336.3 mm (13.24 in.)
	Depth	129.5 mm (5.10 in.)
Weight (approximate)	Instrument only	2.7 kg (6.0 lbs)
	with 1 battery	3.2 kg (7.0 lbs)
	with 2 batteries	3.7 kg (8.0 lbs)

- 1 **As defined in IEC 61010-1: 2001.**
- 2 **As defined in IEC 60529: 2001.**

Oscilloscope EMC Certifications and Compliances

European Union	<p>Meets the intent of Directive 89/336/EEC for Electromagnetic Compatibility. Compliance was demonstrated to the following specifications as listed in the Official Journal of the European Communities:</p> <p>EN 61326, EMC requirements for Class A electrical equipment for measurement, control, and laboratory use^{1,2}</p> <p>IEC 61000-4-2, Electrostatic discharge immunity (Performance criterion B)</p> <p>IEC 61000-4-3, RF electromagnetic field immunity (Performance criterion A)³</p> <p>IEC 61000-4-4, Electrical fast transient/burst immunity (Performance criterion B)</p> <p>IEC 61000-4-5, Power line surge immunity (Performance criterion B)</p> <p>IEC 61000-4-6, Conducted RF immunity (Performance criterion A)⁴</p> <p>IEC 61000-4-11, Voltage dips and interruptions immunity (Performance criterion B)</p> <p>EN 61000-3-2, AC power line harmonic emissions</p> <p>EN 61000-3-3, Flicker</p>
----------------	---

- 1 Emissions that exceed the levels required by this standard may occur when this equipment is connected to a test object.**
- 2 To ensure compliance to the standards listed above, attach only high quality shielded cables to this instrument. High quality shielded cables typically are braid and foil types that have low impedance connections to shielded connectors at both ends.**
- 3 The increase in trace noise while subjected to a test field (3 V/m over the frequency range 80 MHz to 1 GHz, with 80% amplitude modulation at 1 kHz) is not to exceed 2 major divisions peak-to-peak. Ambient conducted fields may induce triggering when the trigger threshold is offset less than 1 major division from channel reference.**
- 4 The increase in trace noise while subjected to a test field (3 V/m over the frequency range 150 kHz to 80 MHz, with 80% amplitude modulation at 1 kHz) is not to exceed 1 major division peak-to-peak. Ambient conducted fields may induce triggering when the trigger threshold is offset less than 0.5 major divisions from channel reference.**

Oscilloscope EMC Certifications and Compliances (Cont.)

Australia/New Zealand	Meets the intent of Australian EMC Framework as demonstrated to the following specification: AS/NZS 2064.1/2
-----------------------	--

Oscilloscope Safety Certifications and Compliances

Certifications	CAN/CSA C22.2 No. 1010.1, 2004 UL61010-1, 2004
CSA Certified Power Cords	CSA Certification includes the products and power cords appropriate for use in the North America power network All other power cords supplied are approved for the country of use
Pollution Degree 2	Do not operate in environments where conductive pollutants may be present.
Overvoltage Category	Category: Examples of Products in this Category: CAT III Distribution-level mains, fixed installation CAT II Local-level mains, appliances, portable equipment CAT I Signal levels in special equipment or parts of equipment, telecommunications, electronics

Adjustment (Factory Calibration) Interval

The recommended calibration interval is one year

P2220 Probe Specifications

Electrical characteristics	10X position	1X position
Bandwidth	DC to 200 MHz	DC to 6 MHz
Attenuation Ratio	10:1 ± 2%	1:1 ± 2%
Compensation Range	15 pF-25 pF	Compensation is fixed; correct for all oscilloscopes with 1 MΩ input
Input Resistance	10 M Ω ± 3% at DC	1 MΩ ± 3% at DC
Input Capacitance	13.0 pF-17.0 pF	80 pF-110 pF
Rise Time, typical	< 2.2 ns	< 50.0 ns
Maximum Input Voltage ¹ Between Tip (Signal) and the Reference Lead	10X position	300 V _{RMS} CAT II or 300 V DC CAT II 150 V _{RMS} CAT III or 150 V DC CAT III 420 V peak, <50% DF, <1 s PW 670 V peak, <20% DF, <1 s PW
	1X position	150 V _{RMS} CAT II or 150 V DC CAT II 100 V _{RMS} CAT III or 100 V DC CAT III 210 V peak, <50% DF, <1 s PW 330 V peak, <20% DF, <1 s PW
	300 V _{RMS} ; derate at 20 dB/decade above 900 kHz to 13 V peak AC at 3 MHz and above. For non-sinusoidal waveforms, peak value must be less than 450 V. Excursion above 300 V should be less than 100 ms duration. RMS signal level including any DC component removed through AC coupling must be limited to 300 V. If these values are exceeded, damage to the instrument may result. Refer to the Overvoltage Category on the next page.	
Maximum Input Voltage ¹ Between Tip (Signal) and the Earth Ground	10X position	300 V _{RMS} CAT II or 300 V DC CAT II 150 V _{RMS} CAT III or 150 V DC CAT III 420 V peak, <50% DF, <1 s PW 670 V peak, <20% DF, <1 s PW
	1X position	150 V _{RMS} CAT II or 150 V DC CAT II 100 V _{RMS} CAT III or 100 V DC CAT III 210 V peak, <50% DF, <1 s PW 330 V peak, <20% DF, <1 s PW
Maximum Voltage Between the Reference Lead and Earth Ground	30 V _{RMS} ²	

P2220 Probe Specifications

- 1 As defined in IEC61010-1: 2001. See certifications and compliances in Table 3.
- 2 The float voltage must be subtracted from the tip to earth ground voltage. For example, if the reference lead is floated to 30 V_{RMS}, the tip voltage to the reference lead is limited to 270 V_{RMS}.

P2220 Probe Specifications (Cont.)**Certifications and Compliances**

EC Declaration of Conformity	Compliance was demonstrated to the following specification as listed in the Official Journal of the European Communities: Low Voltage Directive 73/23/EEC as amended by 93/68/EEC:	
	EN 61010-1 2001	Safety requirements for electrical equipment for measurement, control, and laboratory use
	EN 61010-2-031 2003	Particular requirements for hand-held probe assemblies for electrical measurement and test
Overvoltage Category	Category	Examples of Products in this Category
	CAT III	Distribution-level mains, fixed installation
	CAT II	Local-level mains, appliances, portable equipment
	CAT I	Signal levels in special equipment or parts of equipment, telecommunications, electronics
Pollution Degree 2	Do not operate in environments where conductive pollutants may be present.	
Safety	UL61010-1, 2004 & UL61010B-2-031, 2003 CSA C22.2 No. 1010.1-92 & CAN/CSA C22.2 No. 1010.2.031-94 IEC61010-031: 2001 EN61010-031: 2001	

P2220 Probe Specifications (Cont.)

Environmental characteristics

Pollution Degree	Pollution Degree 2 ¹ . Do not operate in an environment where conductive pollutants may be present.	
Temperature	Operating	0 °C to 50 °C (32 °F to 122 °F)
	Nonoperating	-40 °C to 71 °C (-40 °F to +159.8 °F)
Cooling Method	Convection	
Humidity	+104 °F (+40 °C) or below	≤ 90% relative humidity
	+105 °F - 122 °F (+41 °C to +50 °C)	≤ 60% relative humidity
Altitude	Operating	10,000 ft (3,000 m)
	Nonoperating	40,000 ft (15,000 m)

¹ As defined in IEC 61010-1:2001.

² As defined in IEC 60529. 2001.

Appendix B: Accessories

All accessories (standard and optional) are available by contacting your local Tektronix field office.

Standard Accessories



P2220 1X, 10X Passive Voltage Probe. The P2220 probes have a 6 MHz bandwidth with a rating of 150 V_{RMS} CAT II when the switch is in the 1X position, and a 200 MHz bandwidth with a rating of 300 V_{RMS} CAT II when the switch is in the 10X position.

An English-only probe manual is included.

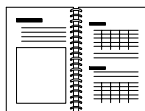

TPS2000 Series Oscilloscope User Manual. A single user manual is included. Refer to the Optional Accessories for a complete list of available language manuals.

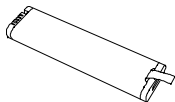

TPSBAT Battery Pack. Battery packs make the oscilloscope portable. The length of time you can operate the oscilloscope from battery packs depend on the oscilloscope model. See page 1-8.

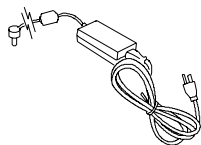

Oscilloscope AC Adaptor with Cord. Refer to Optional Accessories on page B-2 for a list of available international power cords. AC adaptors are not rated for temperatures below 0 °C (32 °F) or intended for outdoor use.

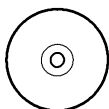

TDSPCS1 CD-ROM. The TDSPCS1 OpenChoice™ PC Communications Software provides easy transfer of data from the oscilloscope to a PC.

Optional Accessories

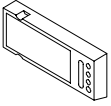

TPS2PWR1 Application. The TPS2PWR1 Power Analysis Application extends power measurement capabilities.

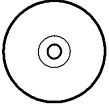

WST-RO CD-ROM. The WST-RO WaveStar Software for Oscilloscopes allows you to control the oscilloscope from a PC.

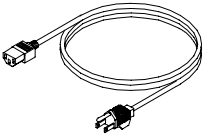

International Power Cords. In addition to the power cord shipped with your oscilloscope, you can obtain the following cords:

Option A0, North American	120 V, 60 Hz	161-0066-00
Option A1, European	230 V, 50 Hz	161-0066-09
Option A2, United Kingdom	230 V, 50 Hz	161-0066-10
Option A3, Australian	240 V, 50 Hz	161-0066-11
Option A5, Switzerland	230 V, 50 Hz	161-0154-00
Option A10, China	220 V, 50 Hz	161-0304-00

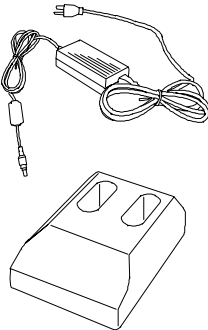

TPSCHG Battery Charger. The TPSCHG external battery charger accommodates two battery packs. Refer to International Power Cords for a list of available power cords. Battery chargers are not rated for temperatures below 0 °C (32 °F) or intended for outdoor use.

Optional Accessories (Cont.)

Hi-Voltage Probe*

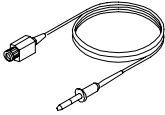

P5120 Passive Hi-Voltage Probe. The probe is 200 MHz, 20X, 1000 V_{RMS} and 3 meters (3.2 yards) long.

AC Current Probe*

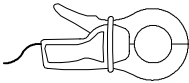

A621 AC Only Current Probe. The probe is 5 Hz to 50 Hz with 1/10/100 mV/A settings, and 2000 APK.

AC/DC Current Probes*

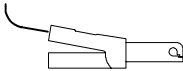

A622 AC/DC Current Probe. The probe is DC to 100 MHz with 10/100 mV/A settings, and 100 APK.

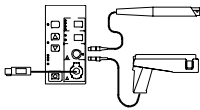

TCP303 AC/DC Current Probe (requires TCPA300 Amplifier). The probe is DC to 15 MHz with 5/50 mV/A settings, 150 A_{RMS}, and 500 APK.

TCP305 AC/DC Current Probe (requires TCPA300 Amplifier). The probe is DC to 50 MHz with 5/10 mV/A settings, 50 ADC, and 500 APK.

TCP312 AC/DC Current Probe (requires TCPA300 Amplifier). The probe is DC to 100 MHz with 1/10 A/V settings, 30 ADC, and 500 APK.

* Refer to the www.tektronix.com web site for a list of other compatible high voltage and current probes.

Optional Accessories (Cont.)

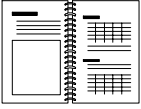

TPS2000 Series Digital Storage Oscilloscope User Manuals. The user manual is available in these languages:

English	071-1441-XX
French	071-1442-XX
Italian	071-1443-XX
German	071-1444-XX
Spanish	071-1445-XX
Japanese	071-1446-XX
Portuguese	071-1447-XX
Simplified Chinese	071-1448-XX
Traditional Chinese	071-1449-XX
Korean	071-1450-XX
Russian	071-1451-XX

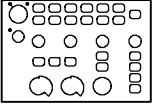

2-channel overlay

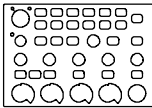

4-channel overlay



P2220 1X, 10X Probe Instructions. The P2220 probe manual (071-1464-XX, English) provides information on the probe and probe accessories.



P5120 20X Passive Hi-Voltage Probe Instructions. The P5120 probe manual (071-1463-XX, English) provides information on the probe and probe accessories.

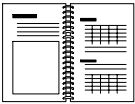

TDS200, TDS1000, TDS2000, and TPS2000 Series Digital Oscilloscope Programmer Manual. The programmer manual (071-1075-XX English) provides command and syntax information.

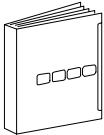

TPS2000 Series Digital Storage Oscilloscope Service Manual. The service manual (071-1465-XX, English) provides module-level repair information.

Optional Accessories (Cont.)

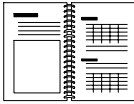

TPS2PWR1 Power Analysis Application User Manuals.

The user manual is available in these languages:

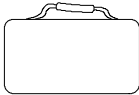
English	071-1452-XX
French	071-1453-XX
Italian	071-1454-XX
German	071-1455-XX
Spanish	071-1456-XX
Japanese	071-1457-XX
Portuguese	071-1458-XX
Simplified Chinese	071-1459-XX
Traditional Chinese	071-1460-XX
Korean	071-1461-XX
Russian	071-1462-XX

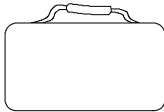

Soft Case. The soft case (AC2100) protects the oscilloscope from damage and provides space for probes, batteries, battery charger, power cord, and manuals.



Transit Case. The transit case (HCTEK321) provides shock, vibration, impact and moisture protection for the oscilloscope when you transport it from one place to another. The required soft case fits inside the transit case.

Appendix C: Cleaning

General Care

Do not store or leave the oscilloscope where the LCD display will be exposed to direct sunlight for long periods of time.



CAUTION. *To avoid damage to the oscilloscope or probes, do not expose them to sprays, liquids, or solvents.*

Cleaning

Inspect the oscilloscope and probes as often as operating conditions require. To clean the exterior surface, perform the following steps:

1. Remove loose dust on the outside of the oscilloscope and probes with a lint-free cloth. Use care to avoid scratching the clear glass display filter.
2. Use a soft cloth dampened with water to clean the oscilloscope. Use an aqueous solution of 75% isopropyl alcohol for more efficient cleaning.



CAUTION. *To avoid damage to the surface of the oscilloscope or probes, do not use any abrasive or chemical cleaning agents.*

Appendix D: Default Setup

This appendix describes the options, buttons and controls that change settings when you push the DEFAULT SETUP button. For a list of settings that do not change, refer to page D-4.

NOTE. When you push the DEFAULT SETUP button, the oscilloscope displays the CH1 waveform and removes all other waveforms.

Default settings

Menu or system	Option, button or knob	Default setting
ACQUIRE	(three mode options)	Sample
	Averages	16
	RUN/STOP	RUN
AUTORANGE	Autorange	Off
	Mode	Vertical and Horizontal
CURSOR	Type	Off
	Source	CH1
	Horizontal (amplitude)	+/- 3.2 divs
	Vertical (time)	+/- 4 divs
DISPLAY	Type	Vectors
	Persist	Off
	Format	YT

Default setup (Cont.)

Menu or control	Option	Default setting
HORIZONTAL	Window	Main
	Trig Knob	Level
	POSITION	0.00 s
	SEC/DIV	500 μ s
	Window Zone	50 μ s
MATH	Operation	-
	Sources	CH1 - CH2
	Position	0 divs
	Vertical Scale	2 V
	FFT operation: Source	CH1
	Window	Hanning
	FFT Zoom	X1
MEASURE (all)	Source	CH1
	Type	None
TRIGGER (common)	Type	Edge
	Source	CH1
TRIGGER (Edge)	Slope	Rising
	Mode	Auto
	Coupling	DC
	LEVEL	0.00 V

Default setup (Cont.)

Menu or control	Option	Default setting
TRIGGER (Video)	Polarity	Normal
	Sync	All Lines
	Standard	NTSC
TRIGGER (Pulse)	When	=
	Set Pulse Width	1.00 ms
	Polarity	Positive
	Mode	Auto
	Coupling	DC
Vertical system, all channels	Coupling	DC
	BW Limit	Off
	Volts/Div	Coarse
	Probe	Voltage
	Voltage Probe Attenuation	10X
	Current Probe Scale	10 A/V
	Invert	Off
	POSITION	0.00 divs (0.00 V)
VOLTS/DIV	1.00 V	

The DEFAULT SETUP button does not reset the following settings:

- Language option
- Saved setups
- Saved reference waveforms
- Front panel backlight
- Display contrast and brightness
- Calibration data
- Printer setup
- RS-232 setup
- Probe setup (type and attenuation factor)
- Date and time
- Current folder on the CF card

Appendix E: Font Licenses

The following license agreements cover Asian fonts used in TPS2000 series oscilloscopes.

Copyright © 1988 The Institute of Software, Academia Sinica.

Correspondence Address: P.O.Box 8718, Beijing, China 100080.

Permission to use, copy, modify, and distribute this software and its documentation for any purpose and without fee is hereby granted, provided that the above copyright notices appear in all copies and that both those copyright notices and this permission notice appear in supporting documentation, and that the name of "the Institute of Software, Academia Sinica" not be used in advertising or publicity pertaining to distribution of the software without specific, written prior permission. The Institute of Software, Academia Sinica, makes no representations about the suitability of this software for any purpose. It is provided "as is" without express or implied warranty.

THE INSTITUTE OF SOFTWARE, ACADEMIA SINICA, DISCLAIMS ALL WARRANTIES WITH REGARD TO THIS SOFTWARE, INCLUDING ALL IMPLIED WARRANTIES OF MERCHANTABILITY AND FITNESS, IN NO EVENT SHALL THE INSTITUTE OF SOFTWARE, ACADEMIA SINICA, BE LIABLE FOR ANY SPECIAL, INDIRECT OR CONSEQUENTIAL DAMAGES OR ANY DAMAGES WHATSOEVER RESULTING FROM LOSS OF USE, DATA OR PROFITS, WHETHER IN AN ACTION OF CONTRACT, NEGLIGENCE OR OTHER TORTIOUS ACTION, ARISING OUT OF OR IN CONNECTION WITH THE USE OR PERFORMANCE OF THIS SOFTWARE.

© Copyright 1986-2000, Hwan Design Inc.

You are hereby granted permission under all Hwan Design propriety rights to use, copy, modify, sublicense, sell, and redistribute the 4 Baekmuk truetype outline fonts for any purpose and without restriction; provided, that this notice is left intact on all copies of such fonts and that Hwan Design Int.'s trademark is acknowledged as shown below on all copies of the 4 Baekmuk truetype fonts.

BAEKMUK BATANG is a registered trademark of Hwan Design Inc. BAEKMUK GULIM is a registered trademark of Hwan Design Inc. BAEKMUK DOTUM is a registered trademark of Hwan Design Inc. BAEKMUK HEADLINE is a registered trademark of Hwan Design Inc.

© Copyright 2000–2001 /efont/ The Electronic Font Open Laboratory. All rights reserved.

Redistribution and use in source and binary forms, with or without modification, are permitted provided that the following conditions are met:

3. Redistributions of source code must retain the above copyright notice, this list of conditions and the following disclaimer.
4. Redistributions in binary form must reproduce the above copyright notice, this list of conditions and the following disclaimer in the documentation and/or other materials provided with the distribution.
5. Neither the name of the team nor the names of its contributors may be used to endorse or promote products derived from this font without specific prior written permission.

THIS FONT IS PROVIDED BY THE TEAM AND CONTRIBUTORS “AS IS” AND ANY EXPRESS OR IMPLIED WARRANTIES, INCLUDING, BUT NOT LIMITED TO, THE IMPLIED WARRANTIES OF MERCHANTABILITY AND FITNESS FOR A PARTICULAR PURPOSE ARE DISCLAIMED. IN NO EVENT SHALL THE TEAM OR CONTRIBUTORS BE LIABLE FOR ANY DIRECT, INDIRECT, INCIDENTAL, SPECIAL, EXEMPLARY, OR CONSEQUENTIAL DAMAGES (INCLUDING, BUT NOT LIMITED TO, PROCUREMENT OF SUBSTITUTE GOODS OR SERVICES; LOSS OF USE, DATA, OR PROFITS; OR BUSINESS INTERRUPTION) HOWEVER CAUSED AND ON ANY THEORY OF LIABILITY, WHETHER IN CONTRACT, STRICT LIABILITY, OR TORT (INCLUDING NEGLIGENCE OR OTHERWISE) ARISING IN ANY WAY OUT OF THE USE OF THIS FONT, EVEN IF ADVISED OF THE POSSIBILITY OF SUCH DAMAGE.

Appendix F: TPS2000 Compatible Probe Maximum Voltages

TPS2000 Compatible Probe Maximum Voltages

Passive Probes

Attenuation Gain Setting	<i>P2220</i>		<i>P5120</i>
	1X	10X	20X
Maximum Input Voltage ¹ between Tip (Signal) and the Reference Lead Maximum Input	150 V _{RMS} CAT II or 150 V DC CAT II	300 V _{RMS} CAT II or 300 V DC CAT II	1,000 V _{RMS} CAT II or 1,000 V DC CAT II
Maximum Input Voltage ¹ between Tip (Signal) and Earth Ground	150 V _{RMS} CAT II or 150 V DC CAT II	300 V _{RMS} CAT II or 300 V DC CAT II	1,000 V _{RMS} CAT II or 1,000 V DC CAT II
Maximum Voltage between the Reference Lead and Earth Ground when used with TPS2000 Series	30 V _{RMS} (42.4 V peak)	30 V _{RMS} (42.4 V peak)	600 V _{RMS} CAT II or 600 V DC CAT II

¹ As defined in IEC 61010-1: 2001.

Differential Probes

Differential Probes

Attenuation Gain Setting	<i>P5205 with 1103</i>	
	50X	500X
Maximum Linear Differential Mode Input Voltage ² (between Probe Tips)	130 V (DC + PK AC) CAT I 100 V _{RMS} CAT II or 100 V DC CAT II 600 V _{RMS} CAT III or 600 V DC CAT III	1,300 V (DC + PK AC) CAT I 1,000 V _{RMS} CAT II or 1,000 V DC CAT II
Maximum Linear Common Mode Input Voltage ² (between either + or - Probe Tip and Earth Ground)	1,000 V _{RMS} CAT II or 1,000 V DC CAT II 600 V _{RMS} CAT III or 600 V CAT III	1,000 V _{RMS} CAT II or 1,000 V DC CAT II 600 V _{RMS} CAT III or 600 V DC CAT III

Differential Probes

Attenuation Gain Setting	<i>P5210 with 1103</i>	
	100X	1000X
Maximum Linear Differential Mode Input Voltage ² (between Probe Tips)	560 V (DC + PK AC) 440 V _{RMS} CAT I or 440 V DC CAT I 440 V _{RMS} CAT I or 440 V DC CAT I 100 V _{RMS} CAT III or 100 V DC CAT III	5,600 V (DC + PK AC) 4,400 V _{RMS} CAT I or 4,400 V DC CAT I 4,400 V _{RMS} CAT I or 4,400 V DC CAT I 1,000 V _{RMS} CAT III or 1,000 V DC CAT III
Maximum Linear Common Mode Input Voltage ² (between either + or - Probe Tip and Earth Ground)	2,200 V _{RMS} CAT I or 2,200 V DC CAT I 2,200 V _{RMS} CAT II or 2,200 V DC CAT II 1,000 V _{RMS} CAT III or 1,000 V DC CAT III	2,200 V _{RMS} CAT I or 2,200 V DC CAT I 2,200 V _{RMS} CAT II or 2,200 V DC CAT II 1,000 V _{RMS} CAT III or 1,000 V DC CAT III

Differential Preamplifier

	ADA400A with 1103	
Attenuation Gain Setting	0.1X	1X
Maximum Linear Differential Mode Input Voltage ² (between Probe Tips)	± 80 V (DC + PK AC)	± 10 V (DC + PK AC)
Maximum Linear Common Mode Input Voltage ² (between either + or - Probe Tip and Earth Ground)	± 40 V (DC + PK AC)	± 40 V (DC + PK AC)

Differential Preamplifier

ADA400A with 1103		
Attenuation Gain Setting	10X	100X
Maximum Linear Differential Mode Input Voltage² (between Probe Tips)	$\pm 1 \text{ V (DC + PK AC)}$	$\pm 100 \text{ mV (DC + PK AC)}$
Maximum Linear Common Mode Input Voltage² (between either + or - Probe Tip and Earth Ground)	$\pm 10 \text{ V (DC + PK AC)}$	$\pm 10 \text{ V (DC + PK AC)}$

- 1 As defined in IEC 61010-1: 2001.**
- 2 The float voltage must be subtracted from the tip to earth ground voltage. For example, if the reference lead is floated to 30 V_{RMS}, the tip voltage to the reference lead is limited to 270 V_{RMS}.**



Index

Index

Symbols

- ? in Value readout, 4-4
- ▶ delimiter in manual, xv

A

- Abbreviating, commands, 6-13
- Abort printing, 6-3
- AC adaptors
 - battery charger, 8-7, B-2
 - oscilloscope, 1-6, B-1
- AC coupling
 - trigger, 9-37
 - vertical, 9-52
- Accessories, B-1–B-6
- ACQUIRE button, 2-13, 9-2
- Acquire menu, 9-2
- Acquire signals, basic concepts, 3-6
- Acquisition
 - live display, 9-6
 - single-shot example, 4-21
 - stopping, 9-6
- Acquisition modes, 3-6, 9-2
 - Average, 3-7, 9-5
 - indicators, 2-3
 - Peak Detect, 3-7, 9-3
 - Sample, 3-7, 9-3
- Add waveforms, Math menu, 9-24
- Address, Tektronix, xvii
- Aliasing
 - check for, 3-10
 - FFT, 5-8
 - time domain, 3-9
- Amplitude cursors, 3-15, 9-15
- Amplitude measurements, using cursors, 4-13
- Application, power analysis, B-2
- APPLICATION button, 2-14
- Application examples
 - analyzing a differential communication signal, 4-9
 - analyzing signal detail, 4-19
 - automatic measurements, 4-2
 - autoranging to examine test points, 4-8
 - autoset, using, 4-3
 - averaging, using, 4-20
 - calculating amplifier gain, 4-7
 - capturing a single-shot signal, 4-21
 - cursors, using, 4-13
 - isolated channels to analyze a differential signal, 4-9
 - looking at a noisy signal, 4-19
 - measuring propagation delay, 4-23
 - measuring pulse width, 4-15
 - measuring ring amplitude, 4-13
 - measuring ring frequency, 4-13
 - measuring rise time, 4-17
 - measuring two signals, 4-5
 - optimizing the acquisition, 4-22
 - peak detect, using, 4-19
 - power analysis using Math, 4-11
 - reducing noise, 4-20
 - taking automatic measurements, 4-3
 - taking cursor measurements, 4-13

- triggering on a specific pulse
 - width, 4-25
- triggering on a video signal, 4-27
- triggering on video fields, 4-28
- triggering on video lines, 4-29
- using Autorange to examine test points, 4-8
- using persistence, 4-34
- using the window function, 4-31
- using XY mode, 4-34
- viewing a Math instantaneous power waveform, 4-11
- viewing impedance changes in a network, 4-32

Application key, 2-16

ASCII interface, 6-13

Attenuation, voltage probe, 1-16, 1-19, 9-53

Attenuation switch, 1-19

Auto trigger mode, 9-38

Automatic measurements, 9-25

- ? in Value readout, 4-4
- basic concepts, 3-15

AUTORANGE button, 2-13

Autorange functions, 3-2

- overview, 9-7
- turning off, 9-9

Autorange menu, 9-7

AUTOSET, button, 2-14

Autoset functions, 3-2

- DC level, 9-10
- FFT, 9-12
- noise, 9-11
- overview, 9-10
- pulse signal, 9-13
- sine waves, 9-12
- square wave, 9-13
- Undo, 9-12
- video signal, 9-14
- when to use, 9-11

Autoset menu, 9-10

Average

- acquisition mode, 9-2
- Mean measurement, 9-26

Average acquisition mode, 3-7, 9-5

Average mode, icon, 2-3

B

Bandwidth limit

- trigger, 9-37
- vertical, 9-52

Bandwidth limited, readout, 2-4

Battery packs

- aging, 8-3
- calibration, 8-1, 8-8
 - check, 8-5
- care, 8-1
- charge, 8-6
 - check level, 8-5
 - external, 8-7
 - internal, 8-6
 - temperature, 8-2, 8-6
 - time, 8-6
- charger, 8-7
- charging conditions, 8-2
- charging internally, LED indicator, 2-16
- continuous charge, 8-2, 8-8
- end of life, 8-4
- external charger, B-2
- front panel illumination, 2-2
- installation, 1-8
- internal charger, B-1
- Li-Ion, 8-1
- manage power, 8-1
- operating time, 8-5
- recycling, xvi

- removal, 1-10
 - replacement, 8-11
 - self-discharge, 8-2
 - service, 8-1
 - service life, 8-3
 - storage, 8-2, 8-3
 - temperature, recommended operating, 8-2
 - TPSBAT, 1-8, B-1
 - Bezel buttons, xv
 - Binary data, RS-232 transfer, 6-11
 - BMP file format, 6-4
 - BNC connectors, 1-6
 - Break signals, RS-232 protocol, 6-11
 - Brightness, 9-17
 - Burst waveforms, 5-3
 - Button names, xv
 - BW limit for vertical, 9-52
- ## C
- Calendar, 9-48
 - Calibrate, battery packs, 8-8
 - check charge status, 8-5
 - external charger, 8-9
 - inside analyzer, 8-10
 - length of time, 8-10
 - Calibration, 9-47
 - automatic routine, 1-20
 - Centronics port, 6-2
 - CF card, 7-1
 - CH 1, CH 2, CH 3, or CH 4
 - connectors, 2-15
 - MENU buttons, 2-8
 - Channel
 - coupling, 9-52
 - menu, 9-52
 - scale, 2-4
 - Charge, battery packs, 8-6
 - charge time, 8-6
 - check level, 8-5
 - Charger, battery external, B-2
 - Cleaning, C-1
 - Clock, set date and time, 9-48
 - Coarse resolution, 9-52
 - Command, abbreviating, 6-13
 - Communications ports, 6-2
 - CompactFlash card
 - file management, 7-3
 - File utilities, 9-49
 - formatting, 7-2
 - installation, 7-1
 - PRINT button, 7-4
 - Save operation indicator, 2-14
 - saving files
 - all, 7-5
 - images, 7-7
 - setups, 7-5
 - waveforms, 7-5
 - slot and LED locations, 2-16
 - storage capacity, 7-3
 - Compensation
 - PROBE COMP connector, 2-15
 - signal path, 9-48
 - voltage probe
 - check wizard, 1-16
 - manual, 1-17
 - Connectors
 - BNC, 1-6
 - Centronics port, 6-2
 - CH 1, CH 2, CH 3 and CH 4, 2-15
 - DC input, 1-7
 - EXT TRIG, 2-15
 - probe, 1-5
 - PROBE COMP, 2-15
 - RS-232 port, 6-2

Contacting Tektronix, xvii
Context-sensitive help topics, xiii
Continuously charge battery packs,
8-2, 8-8
Contrast, 9-17
Conventions used in this manual,
xv
Cooling vents, 1-7
Coupling
trigger, 3-5, 9-40
vertical, 9-52, 9-54
CSV file format, 9-32
Current folder, 7-3, 9-49
Current probes, scale setting, 1-20,
9-53
CURSOR button, 2-14, 9-15
Cursor menu, 9-15
Cursors
adjusting, 9-15
Amplitude, 3-15, 9-15
basic concepts, 3-15
Frequency for FFT, 9-15
Magnitude for FFT, 9-15
measurement examples, 4-13
measuring an FFT spectrum,
5-11
Time, 3-15, 9-15
using, 9-15
Cycle RMS measurements, 9-26

D

Data transfer, RS-232 interface,
6-5
Date, 9-48
Date and time readout, 2-4
DC coupling
trigger, 9-37
vertical, 9-52

Default setup
Edge trigger, D-2
Pulse trigger, D-3
recalling, 9-35
Video trigger, D-3
DEFAULT SETUP button
option and control settings, D-1
retained option settings, D-4
Delayed sweep, 9-22
Deleting
files or folders, 9-50
reference waveforms, 9-35
Deleting files or folders, 9-45
Delta readouts in Cursor menu,
9-16
Description, general, 1-1
Diagonal lines in waveform, peak
detect, 9-4
Directories, deleting, 9-45, 9-50
Display
contrast, 9-17
intensity, 9-17
menu, 9-17
persistence, 9-17
readouts, 2-2
style (Invert), 9-52
style of waveforms, 9-18
type, vectors or dots, 9-17
XY format, 9-17
YT format, 9-17
DISPLAY button, 2-14, 9-17
Display Refs menu, 9-35
Displaying waveforms, 9-52
reference, 9-35
Do Self Cal option, 1-20
Dots display type, 9-17
Dual time base, 2-10, 9-21

E

- Edge trigger, 9-37
- EPSIMAGE file format, 6-4
- Error Log, 9-47
- EXT TRIG connector, 2-15
 - probe compensation, 1-17

F

- Factory calibration, 9-49
- Factory setup, D-1
 - recalling, 9-35
- Fall time measurements, 9-27
- Fan, 1-7
- Features, overview, 1-2
- FFT aliasing, 5-8
 - remedies, 5-9
- FFT spectrum
 - applications, 5-1
 - displaying, 5-4
 - magnify, 5-10
 - measuring magnitude and frequency with cursors, 5-11
- Nyquist frequency, 5-3
 - process, 5-1
 - readouts, 5-5
 - Window, 5-6
- FFT Window
 - Flattop, 5-8
 - Hanning, 5-8
 - Rectangular, 5-8
- FFT zoom
 - horizontal, 5-5
 - vertical, 5-4
- Field video trigger, 9-41
- File formats for images, 6-4

- File utilities, 9-49
 - CompactFlash card contents, 9-49
 - creating files or folders, 9-50
 - deleting files or folders, 9-45, 9-50
 - navigating the directory structure, 9-50
 - renaming files or folders, 9-51
 - selecting files or folders, 9-49
- Fine resolution, 9-52
- Firmware updates, 9-50
- Flattop window, 5-8
- Floating measurements, 1-4
- Folders
 - creating, 9-50
 - deleting, 9-45, 9-50
 - renaming, 9-51
- FORCE TRIG button, 2-11
- Format
 - CompactFlash card, 7-2
 - display, 9-17
 - image file, 6-4
 - printer, 6-3
- Frequency, trigger readout, 2-4, 9-38
- Frequency cursors, 3-15, 9-15
 - FFT spectrum, 5-12
- Frequency measurements, 9-26
 - FFT cursors, 5-11
 - using cursors, 4-13
- Front panel illumination, 2-2, 9-47
- Functional check, 1-13
- Fundamental frequency component, 5-5

G

Graticule, 3-14, 9-17
Ground coupling, 9-52

H

Hanger, 1-10
 attaching, 1-11
Hanning window, 5-8
Help scroll LED, xiii
Help system, xiii
Helpful messages, 2-4
High voltage, warning, 1-5
Holdoff, 9-23, 9-46
HOLDOFF control, 2-11
HORIZ MENU button, 2-10
Horizontal
 aliasing, time domain, 3-9
 how to make large adjustment,
 2-9
 menu, 9-21
 position, 3-8
 position marker, 2-3
 scale, 3-9
 Scan mode, 9-6, 9-22
 status, 9-48
Hyperlinks in help topics, xiv

I

I/O errors, RS-232 report, 6-11
Icons
 acquisition modes
 Average, 2-3
 Peak Detect, 2-3
 Sample, 2-3
 Bandwidth limited readout, 2-4

 channel scale, 2-4
 date and time readout, 2-4
 horizontal position marker, 2-3
 inverted waveform readout, 2-4
 Math marker, 4-13
 Reference marker, 2-4
 reference waveforms readout,
 2-4
 time base readout, 2-4
 trigger
 frequency readout, 2-4
 level marker, 2-3
 level readout, 2-4
 position marker, 2-3
 position readout, 2-3
 source, 2-4
 trigger status
 Acq. Complete, 2-3
 Armed, 2-3
 Auto mode, 2-3
 Ready, 2-3
 Scan mode, 2-3
 Stop, 2-3
 Trig'd, 2-3
 trigger type
 Edge, 2-4
 Pulse Width, 2-4
 Video, 2-4
 vertical scale, 2-4
 window time base readout, 2-4
Illumination, color models, 2-2,
 9-47
Image file formats, 6-4
Index for help topics, xiv
Indicators, 2-3
Infrequent events, infinite persis-
 tence, 9-19
Intensity, 9-17
Interfaces for PCs and printers, 6-2

Interpolation, 9-3
Inverted waveform, readout, 2-4
Isolated channels, description, 1-4

L

Languages, 9-47
 how to change, 1-1
Level, 2-11, 3-6
LEVEL control, 2-11
Li-Ion battery packs, 8-1
Line video trigger, 9-41
Lissajous pattern, XY format, 9-20

M

M indicator for Main time base,
 9-22
M marker for Math waveforms,
 4-13
Magnify horizontal, window, 9-21
Magnitude cursors, 3-15, 9-15
 FFT spectrum, 5-12
Main time base, 2-10, 9-21
Manage, battery pack resources,
 8-1
Manuals ordering, B-4
Math
 FFT, 5-1, 5-4
 functions, 9-24
 menu, 9-24
MATH MENU button, 2-8
math waveform, allowed units,
 9-25
Maximum measurements, 9-26
MEASURE button, 2-13
Measure menu, 9-25
Measurements
 automatic, 3-15, 9-25

 basic concepts, 3-14
 cursor, 3-15, 4-13
 cycle RMS, 9-26
 fall time, 9-27
 FFT spectrum, 5-11
 floating, 1-4
 frequency, 9-26
 graticule, 3-14
 maximum, 9-26
 mean, 9-26
 minimum, 9-26
 negative width, 9-27
 peak-to-peak, 9-26
 period, 9-26
 positive width, 9-27
 rise time, 9-27
 types, 9-26

Memory

 removable mass storage, 7-1
 setups, 9-28
 screen images, 9-28
 waveforms, 9-28

Menu system, using, 2-6

Menus

 Acquire, 9-2
 Autorange, 9-7
 Autoset, 9-10
 Cursor, 9-15
 Display, 9-17
 Help, 9-21
 Horizontal, 9-21
 Math, 9-24
 Math FFT, 5-4
 Measure, 9-25
 Print, 9-27
 Save/Recall, 9-28
 Trigger, 9-36
 Utility, 9-47
 Vertical, 9-52
Mercury, end-of-life handling, xvi

Messages, 2-4, 2-5
Minimum measurements, 9-26
Multiply waveforms, Math menu,
9-24
Multipurpose knob, 2-12

N

Navigation, file system, 9-49
Negative width measurements,
9-27
Noise reduction
Average mode , 9-2
Math subtraction, 9-24
trigger coupling, 9-37
vertical bandwidth limit, 9-52
Nonvolatile memory
reference waveform files, 9-28
setup files, 9-28
Normal operation, recall default
setup, 3-3
Normal trigger mode, 9-38
NTSC video standard, 9-41
Nyquist, frequency, 5-3

O

OpenChoice software, B-1
RS-232 interface, 6-8
Operating temperature, battery
packs, 8-2
Operating time, battery packs, 1-8
remaining, 8-8
Option buttons, xv
Option types
Action, 2-6
Circular List, 2-6
Radio, 2-7
Options types, Page Selection, 2-6

Oscilloscope
do not block vents, 1-7
front panels, 2-1
power through AC adaptor, 1-6
set date and time, 9-48
specifications, A-1–A-14
stewardship, xvi
understanding functions, 3-1

P

P2220 probe specifications,
A-16–A-18
PAL video standard, 9-41
Panning
horizontal, 3-8
vertical, 3-8
PCX file format, 6-4
Peak Detect acquisition mode, 3-7,
9-3
Peak Detect mode, 9-2
icon, 2-3
Peak-to-Peak measurements, 9-26
Peak-to-peak noise, 9-19
Period measurements, 9-26
Persistence, 9-17, 9-19
erased with Horizontal menu
changes, 9-23
Phase differences, 9-20
Phone number, Tektronix, xvii
Polarity
Pulse Width trigger, 9-42
Video trigger sync, 9-41
Ports, communications, 6-2
Position
horizontal, 3-8, 9-21
trigger, 9-40
vertical, 9-52

- POSITION control
 - horizontal, 2-9
 - vertical, 2-8
 - Positive width measurements, 9-27
 - Power
 - manage battery packs, 8-1
 - oscilloscope AC adaptor, 1-6
 - specifications, A-11
 - Power analysis application, ordering, B-2
 - Power cords, 1-10
 - ordering, B-2
 - Power Cycle count, 9-47
 - Pretrigger, 3-4
 - Pretrigger view, 9-40
 - PRINT button, 2-14, 9-27
 - PRINT Button option, 9-29
 - saving to a CF card, 7-4
 - Printer
 - RS-232 interface, 6-5
 - setup, 6-3
 - Printing
 - abort, 6-3
 - screen data, 6-5, 9-27
 - testing the port, 6-4
 - PROBE CHECK button, 1-16
 - Probe Check Wizard, voltage probes, 1-16
 - PROBE COMP connections, 2-16
 - Probe manuals ordering
 - P2220 1X/10X passive, B-4
 - P5120 20X hi-voltage, B-4
 - Probe option
 - match current probe scale, 1-20
 - match voltage probe attenuation, 1-19
 - Probes
 - 1X attenuation and bandwidth limit, 1-19
 - Attenuation switch, 1-19
 - compensation, 2-16
 - current and scale, 1-20
 - optional accessories, B-3
 - P2220 standard, 1-13
 - reference lead, isolated channel connections, 1-6
 - safety, 1-15
 - specifications, A-16–A-18
 - voltage and attenuation, 9-53
 - voltage probe check wizard, 1-16
 - voltage probe manual compensation, 1-17
 - voltage ratings, 1-5
 - Product support, contact information, xvii
 - Programmer manual ordering, B-4
 - Pulse signal, Autoset function, 9-13
 - Pulse width measurements, using cursors, 4-15
 - Pulse Width triggering, 9-42
- ## R
- Readouts
 - FFT (Math), 5-5
 - general, 2-2
 - Recall
 - factory setup (default), 3-3
 - setups, 3-3, 9-35
 - waveforms, 9-36
 - Recall Setup menu, 9-33
 - Recall Waveform menu, 9-34
 - Rectangular window, 5-8
 - Reference
 - lead for probe, 1-15
 - marker, 2-4

- probe terminal, 1-15
- terminal, 2-16
- Reference lead, isolated channel
 - connections, 1-6
- Reference waveforms
 - readout, 2-4
 - removing, 9-35
 - saving and recalling, 9-36
- Remote control using RS-232
 - interface, 6-5
- Removable memory storage, 7-1
- Removing waveforms, 9-52
- Renaming files or folders, 9-51
- Replace battery packs, 8-11
- Resolution, fine, 9-54
- Rise time measurements
 - automatic, 9-27
 - using cursors, 4-17
- RLE file format, 6-4
- RMS measurements, 9-26
- Roll mode. *See scan mode*
- RS-232 port, 6-2
 - cable part numbers, 6-6
 - connecting a cable, 6-6
 - connector pinout, 6-12
 - setup, 6-5
- RS-232 protocol
 - Break signals, 6-11
 - I/O errors, 6-11
 - setup options, 6-7
 - testing, 6-8
 - troubleshooting, 6-9
- RUN/STOP button, 2-14, 9-5
 - steps taken by the oscilloscope when pushed, 3-4
- S**
- Safety summary, vii
- Sample acquisition mode, 3-7, 9-2, 9-3
- Sample mode, icon, 2-3
- Sample rate, maximum, 9-3
- Save, setups, 3-2
- Save All menu, 9-29
- Save Image menu, 9-30
- Save Setup menu, 9-31
- SAVE to a CompactFlash card, 2-14
- Save Waveform menu, 9-32
- SAVE/RECALL button, 2-13
- Save/Recall menu, 9-28
- Saving
 - All files to a CF card, 7-4
 - image files to a CF card, 7-7
 - setups, 9-35
 - waveforms, 9-36
- Scale
 - current probe, 1-20, 9-53
 - horizontal, 3-8
 - vertical, 3-8
- Scaling waveforms, basic concepts, 3-8
- Scan mode, 9-6, 9-22
- Scanning waveforms, 9-22
- Screen buttons, xv
- Screen data
 - saving to a file, 7-7
 - sending to a printer, 6-5
 - sending to an external device, 6-5
- SEC/DIV control, 2-10, 9-22
- SECAM video standard, 9-41
- Security lock, 1-12
- Self calibration, 1-20
- Service
 - battery packs, 8-1
 - error log as a reference, 9-47

Service manual ordering, B-4
Service support, contact information, xvii
Set date and time, 9-48
SET TO 50% button, 2-11
SET TO ZERO button, 2-10
Setups
 basic concepts, 3-2
 saving and recalling, 9-28
Side-menu buttons, xv
Signal path compensation, 9-48
Sine waves, Autoset function, 9-12
SINGLE SEQ button, 9-5
 steps taken by the oscilloscope when pushed , 3-4
Single-shot signal, application example, 4-21
Slope, 3-6
Soft case ordering, B-5
Soft keys, xv
Software
 OpenChoice , B-1
 TPS2PWR1 power analysis, B-2
 WaveStar, B-2
Source
 Ext, 9-39
 Ext/10, 9-39
 Ext/5, 9-39
 trigger, 3-4, 9-37, 9-41, 9-42
Specifications
 oscilloscope, A-1–A-14
 P2220 probe, A-16–A-18
Square wave, Autoset function, 9-13
Status
 miscellaneous, 9-48
 system, 9-47
Store battery packs, 8-3
Subtract waveforms, Math menu, 9-24

Sweep
 delayed, 9-22
 horizontal scale, 9-22
Sync
 video polarity, 9-41
 video trigger line or field, 9-41
Sync pulse, 9-42

T

TDSPCS1 OpenChoice software, B-1
Technical support, contact information, xvii
Tektronix, contacting, xvii
Temperature, battery packs charge, 8-6
TIFF file format, 6-4
Time base, 3-7
 Main, 2-10, 9-21
 readout, 2-4
 Window, 2-10, 9-21
Time cursors, 3-15, 9-15
Time domain , waveform, 5-2
TPS2PWR1 application ordering, B-2
TPS2PWR1 manual ordering, B-5
TPSBAT battery pack ordering, B-1
TPSCHG battery charger ordering, B-2
Transient waveforms, 5-3
Transit case ordering, B-5
Trickle charge, battery packs, 8-2, 8-8
TRIG MENU button, 2-11
TRIG VIEW button, 2-11
Trigger
 coupling, 3-5, 9-37, 9-40

- definition, 3-3
- edge, 9-37
- external, 9-41
- force, 9-45
- frequency readout, 2-4, 9-38, 9-43
- holdoff, 2-11, 9-23, 9-46
- level, 2-11, 3-6, 9-36
- level marker, 2-3
- level readout, 2-4
- menu, 9-36
- modes, 3-5
 - Auto, 9-38
 - Normal, 9-38
- polarity, 9-42
- position, 3-5
- position marker, 2-3
- position readout, 2-3
- pretrigger information, 9-40
- slope, 3-6, 9-37
- source, 2-4, 3-4, 9-37, 9-42
- status, 9-48
- status indicators, 2-3
- sync, 9-42
- type indicator, 2-4
- types, 3-4
- video, 9-41, 9-42
- view, 2-11, 9-42

U

- URL, Tektronix, xvii
- UTILITY button, 2-14
- Utility menus, 9-47

V

- Value readout, ? displays, 4-4
- Vectors, 9-17

- Vertical
 - menu, 9-52
 - position, 3-8
 - position knob, 2-8
 - scale, 3-8
 - status, 9-48
- Video signal, Autoset function, 9-14
- Video trigger, 9-41
 - application example, 4-27
- Voltage ratings, understand for probes, 1-5
- Volts/Div
 - Coarse, 9-52
 - Fine, 9-52
- VOLTS/DIV control, 2-8

W

- W indicator for Window time base, 9-22
- Waveforms
 - acquire data, 3-6
 - burst, 5-3
 - compression, 9-22
 - digitized, 3-6
 - display style meaning, 9-18
 - expansion, 9-22
 - Math instantaneous power, 4-11
 - position, 3-8
 - remove from screen, 9-54
 - scale, 3-8
 - scanning, 9-6
 - take measurements, 3-14
 - time domain, 5-2
 - transient, 5-3
- WaveStar software, ordering, B-2
- Web site address, Tektronix, xvii

Window time base, 2-10, 9-21
 readout, 2-4
Window Zone, 9-21, 9-23
Windows, FFT spectrum, 5-6
WST-RO WaveStar software,
 ordering, B-2

X

XY
 application example, 4-34
 display format, 9-17, 9-20

Y

YT, display format, 9-17

Z

Zoom, 4-31
 See also Window Zone
 FFT, 5-10
 HORIZ menu, 9-21

